

Our Environment

Check Point 01

Q. 1. When do we consider a given substance as waste?

Answer: Waste is something unwanted or unusable material. It is any material which is no longer useful as it has served its purpose or at the end of the process has no further use and it is generally discarded. For example, Garbage that we daily produce in our home. Food that we eat goes into our body. It is then acted upon by various specific enzymes which are needed for the breakdown of these large food molecules into simpler small molecules which provide energy. Materials like plastic which cannot be broken down by bacteria's or enzymes are non-biodegradable (cause threat to human health). Hence these products are also called waste. For example polythene bags, metal scraps.

Q. 2. In what way can biodegradable substances be used by farmers?

Answer: Biodegradable wastes are those substances that can be broken down by biological processes (like by enzyme or bacterial action). For Examples: cattle dung, cotton, jute, paper, fruit and vegetable peels, leaves etc.

They can be used by farmers in various ways:

- a) Cattle dung is used as natural fertilizers for crops and plants. It is also cost-free.
- b) Jute can be used to prepare bags for storing grains.
- c) Vegetable peels can be used as food for cattle's. Etc.

Q. 3. Besides natural degradation by microbes, what are the other ways to dispose of biodegradable wastes?

Answer: These biodegradable wastes are animal or plant matter that breaks down naturally with exposure to microorganisms, heat, and oxygen. There are other ways also for their decomposition:

- a) Collect all the material and burn it in a pit.
- b) React it with some strong acid. But both these ways are not good for nature.
- c) Recycling them into a usable material which is called composting. It is done in a sealed container (no presence of air). It will get converted into humus-like material which is a good fertilizer for plants. This step is eco-friendly.

Q. 4. Why is plastic bag called non-biodegradable while the paper is not?

Answer: Plastic bag cannot be broken down by microorganisms. It will remain in the environment for many years. Paper is a biodegradable material is made from other natural products like fruits, plants etc. Hence paper can be degraded naturally by the action of microorganisms in a few months.

Q. 5. What is the most characteristic feature of non-biodegradable wastes?

Answer: The most important characteristic features of these indecomposable products is that they are formed from non-organic matter.

It is the material not derived from living matter. And hence will pose a threat to eco-system.

Q. 6. Write any one effect of non-biodegradable substances.

Answer: These non-organic matters can prolong exist in the environment without getting broken down by biological processes and will cause harm to the environment.

For example Various plastic bags, if any of them is eaten by an animal then it can choke its digestive system. These materials can only be digested by specific enzymes, but they are not present in the animal's body. Hence it will lead to the death of that animal.

Check Point 02

Q. 1. From the list given below, choose an artificial ecosystem. Pond, crop field, lake, forest.

Answer: A community made up of both living and nonliving organisms forms an ecosystem. The type of ecosystem which is made by human beings is called as artificial ecosystem. Among the above mentioned - Pond and crop fields are manmade ecosystem.

Q. 2. In what way, the biotic components of an ecosystem are different from abiotic components?

Answer:

	Biotic components	Abiotic Components
Are they living things?	YES	NO
Examples	Animals, plants, fungi, bacteria – all living things	Forest fires, water, climate, habitat, soil, minerals
Main categories	Producers, consumers, decomposers	Atmosphere, chemical elements, sunlight/ temperature, wind and water
Main types	Living things	Chemical and physical things

Q. 3. Producers are also referred to as the autotrophs. Why?

Answer: Organisms which can produce their own food like sugar and starch from inorganic substances using photosynthesis in the presence of chlorophyll are called producers. And an autotroph is also an organism that can produce its own food using light, water, carbon dioxide, or other chemicals.

Green plants, algae, and certain bacteria are examples of autotrophs that are producers.

Q. 4. Why herbivores also known as first order consumers?

Answer: Organisms which take their food prepared by plants and plant products are called herbivores. These are the organisms that cannot make their own food. So they depend directly on green plants for food and then are referred to as first or primary order consumers. Herbivorous animals like elephant, camel, cow, buffalo, deer, sheep, goat, rabbit etc. are the first order consumers.

Q. 5. Zebra, jackals, lions, goat, horse, wolves and sheep. Identify the first order consumers from those given above. Give a reason to support your answer.

Answer: Zebra, goat, horses and sheep are all those organisms which eat producers (green plants) for energy and hence are herbivores. They all cannot make food by themselves hence; they feed on plants which can make food for themselves.

Q. 6. Based on their feeding habits, differentiate parasites from decomposers.

Answer: Parasites have heterotrophic mode of nutrition where a parasitic organism lives on the body surface or inside the body of another type of organism (a host) and gets nutrition directly from the body of the host. For Example: Plasmodium, Lice, tape worm, round worm etc. And decomposers are organisms that get energy by decaying or breaking down chemically the remains of dead organisms. When an organism dies,

decomposers decay the body extracting the last bit of energy from it. For example: fungi and bacteria.

Check Point 03

Q. 1. In three words, describe the relationship of organisms working in a food chain.

Answer: The relationship of organisms working in a food chain can be described as “FLOW OF ENERGY”. It is from producers to consumers to decomposers. Each group depends on each other for food and energy.

They will not be able to survive if one group were removed. In general, the flow of energy in an ecosystem starts with sunlight (the ultimate source of all energy on Earth) which is absorbed by the producers, goes to the consumers, then to the decomposers, and back to the producers to start all over again.

Q. 2. Identify the members present at the bottom and top of a terrestrial food chain.

Answer: Terrestrial food chain shows a relationship between plants and animals found on deserts, grasslands, and forests.

The energy pyramid has a large base and becomes smaller at the top.

At the bottom or the first level are the producers. Here, the energy and the number of organisms are very high. For each level or feeding stage, the energy and number of organisms decrease so the pyramid becomes smaller at the top. And at the top are carnivores like a tiger, eagle, etc.

Q. 3. Consider a food chain of the following: Fish, crab, phytoplankton, shark. Arrange the above chain in the proper order of trophic level.

Answer:



This trophic level is a depiction of the pond ecosystem.

- The first level is represented by the producers or the autotrophs; for example, phytoplankton and plants. They prepare their own food with the help of energy from sunlight through the process of photosynthesis.
- The second trophic level is characterized by the presence of primary consumers such as crabs inhabiting the pond. Organisms in this level consume the phytoplanktons or producers.
- The third level comprises of the omnivores, especially the fish species, which can feed on both plants.
- The fourth and the top most level is for carnivores or tertiary consumers which are flesh eaters.

Q. 4. What percentage of solar radiation is absorbed by green plants for photosynthesis?

Answer: Between 98 and 99 percent of solar energy reaching the Earth is reflected from leaves and other surfaces and absorbed by other molecules, which convert it to heat. Green plants capture about 1 % of the solar energy using chlorophyll in their leaves. Photosynthesis is the chemical process by which producers capture light energy from the sun and use it to combine water with air to form sugar or food. The chemical equation is:

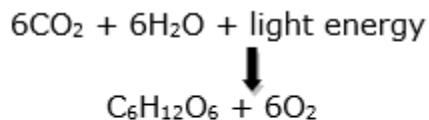

[carbon dioxide + water + sunlight yields sugar (food) and oxygen]

Q. 5. In which form is the 10% energy available for transfer?

Answer: It is transferred in the form of chemical energy. The producers capture the energy present in sunlight and convert it into chemical energy which is passed into onto other trophic levels. This means that when primary consumers eat plants they are able to turn up only 10% of food for their own body and the rest is lost in the form of heat. And this 10% of nutrients only are available for the next level of consumers.

Q. 6. Fertilizers and other chemicals used in agriculture are harmful to us. Give reason.

Answer: Farmers use various fertilizers and pesticides (chemicals) to protect their crops and plants from diseases. These chemicals are absorbed by the plants along with water and minerals from the soil and are taken by aquatic plants and animals as well.

And since these chemicals are non-biodegradable, they will remain in the food chain. Humans are the final consumers of every food chain hence, all of this chemical gets in their body when they feed on organisms or plants of the lower trophic level. In this way, these fertilizers can cause harm to us.

Q. 7. Identify the organisms from the following food chain which will respectively have a maximum and minimum concentration of chemicals in its body? Peacock, frog, snake, grasshopper.

Answer: Grasshopper will have the minimum and peacock will have the maximum concentration of chemicals in their body.

Explanation: Among all the animals mentioned here, the grasshopper is the primary consumer which will eat plants having chemicals so they are the first one to feed on them. The chemicals inside the grasshoppers will start damaging his whole body and as the food chain proceeds grasshopper will be eaten by frog, which will be eaten by a snake. And by this time the snake's body will also get damaged from inside with chemicals as they cannot be degraded. Hence when peacock will feed on the snake, he will have the maximum concentration of chemicals inside its body.

Check Point 04

Q. 1. Ozone present in the atmosphere is very important for sustenance of life on earth. Justify.

Answer: When UV radiations from the sun reach the earth's atmosphere which is heavily rich in oxygen. Then these UV rays split molecular oxygen (O_2) into free oxygen (O). Afterward, this free oxygen reacts with molecular oxygen; it forms ozone (O_3).

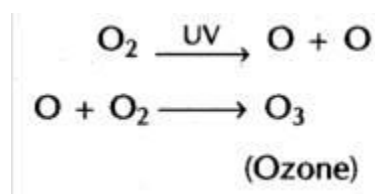

This ozone now protects the earth from harmful UV radiations of the sun, by allowing only some percent of rays to fall on the earth's surface. Ozone acts as a filter of sun rays. These rays can cause skin cancer in human and can also affect other living organisms.

Q. 2. The ultraviolet radiations are damaging to living components of the environment. Give a reason.

Answer: When UV (ultraviolet) radiations from the sun reach earth's atmosphere which is heavily rich in oxygen. These high energy UV rays split molecular oxygen (O_2) into free oxygen (O). Afterward, this free oxygen reacts with molecular oxygen; it forms ozone (O_3).

These harmful UV radiations of the sun, can cause skin cancer in human and can cause many health hazards like skin cancer, cataract, destruction of plants, etc.

Q. 3. Efforts are being made for substituting the chemicals like CFCs. Why?

Answer: CFCs are chlorofluorocarbons are the synthetic chemicals which are made by humans artificially, that means they are not the natural products. Excessive use of these CFCs in refrigerators, ACs, fire-extinguishers, etc. causes the depletion of ozone layer. Because then UV radiations will reach the earth's surface destructing the survival of plants and organisms.

Q. 4. Name the process in which wastes are burned at high temperature.

Answer: Waste Combustion is the process of burning waste at very high temperatures. It is the simplest and earliest form of waste disposal. But this method leads to the release of highly toxic chemicals in the environment which is harmful to the organisms.

Q. 5. Untreated sewage being disposed of in waste bodies to lead to water pollution. Suggest the practices that can be included for better disposal of sewage waste.

Answer: All this untreated sewage can be processed in Sewage treatment plants. In this, undesirable substances are removed from waste water by various physical, chemical and biological pathways. It produces semisolid waste which is nothing but manure. This product is more eco-friendly and biodegradable. This won't cause any problem with live organisms.

Q. 6. What can best method be used for the safe disposal of hospital wastes?

Answer: Hospital waste comprises of those biological substances that pose a threat to living organisms. They can spread infections to the living if left untreated or just thrown in normal dustbins. Hence the best method for their complete removal will be combustion. Burning at a very high temperature kills all the bacteria and microorganisms which can spread the disease.

Chapter Exercise

Q. 1. Can biodegradable wastes be harmful?

Answer: Yes, sometimes biodegradable waste can be harmful also.

Because when these materials are decomposed with the help of microorganisms, then there is a release of powerful green house gases. These greenhouse gases when reacting with high energy UV radiations in the atmosphere leads to the depletion of the ozone layer. This will harm the various members of the eco-system.

Q. 2. Which biological factor is responsible for poor vegetation in deserts?

Answer: In deserts, there is little water available for plants and other organisms. Because of which desert soils are dry, and tend to have poor vegetation (plants found in a particular area). Hence lack of water/water scarcity due to low rainfall is responsible for poor vegetation in deserts (less growth of plants in the desert).

Q. 3. Which group of organisms converts organic materials into inorganic forms?

Answer: The breakdown of organic matter and their conversion into basic inorganic forms is called mineralization.

Decomposers are the organisms (e.g., bacteria, fungi, crabs) that breakdown organic constituents (e.g., plant material) to release carbon and other nutrients such as nitrogen (N) and phosphorus (P) as inorganic form.

When an organism dies, decomposers decay or breakdown his body chemically and extract the last bit of energy from it.

Q. 4. Are plants actually producers of energy?

Answer: Yes, plants are the producers of energy. This is the energy absorbed by the plant from sunlight for photosynthesis. Afterwards this energy is transferred to other organisms by the food chain.

For example: Plant → Goat → Lion.

Energy cannot be transferred back to producers because plants cannot eat animals like goat, insects, etc and without eating the energy cannot be transferred.

Q. 5. What do we call the various steps involved in the food chain?

Answer: A food chain is a series of organisms which eat one another. And in this food chain at each level specific type of organisms occupy the same level. Hence, the trophic level is the position of a group of organisms in a food chain. It refers to the mode of nutrition at every different trophic level.

For example Plants (producers) get their nutrition from sunlight and prepare their own food. Then comes the consumers (herbivores) they cannot prepare their own food hence get their nutrition by feeding on plants. Then comes the secondary or tertiary

consumers (carnivores) they get energy by eating other animals. They all get the nutrition from the organisms of lower trophic levels.

Q. 6. Identify A and B in the given figure.

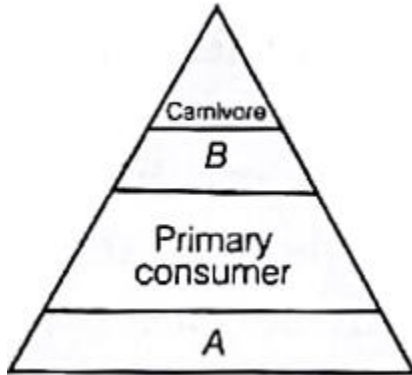

Answer: A are the producers called plants and B are the secondary consumers which are called omnivores.

Plants make their own food with the help of sunlight through the process of photosynthesis and hence are called the producers. They are placed at first trophic level. Secondary consumers are the organisms that can feed both on plants and animals. They come in between primary consumers (herbivores-the plant feeders) and the tertiary consumers (carnivores-the flesh eaters.)

Q. 7. A food chain represents a unidirectional flow of X. What is X?

Answer: A food chain always represents a unidirectional flow of energy from one trophic level to another. As a food chain proceeds from autotrophs to heterotrophs to decomposers energy gets transferred. The flow of energy in an ecosystem starts with sunlight (the ultimate source of all energy on Earth) which is absorbed by the producers, goes to the consumers, then to the decomposers, and back to the producers to start all over again.

Q. 8. Why is straight line food chain not common in the natural ecosystem?

Answer: It is not common in a natural ecosystem, because during energy transfer from one trophic level to another most of the energy is lost in the form of heat. Hence in a natural ecosystem, we cannot see any energy transfer without a loss.

(This will be observed 1000->100->10, instead of 1000->1000->1000)

Q. 9. How many trophic levels does a food chain normally have?

Answer: A food chain normally has three trophic levels. The primary producer, plants who will obtain nutrition from sunlight and prepare food for itself and for the

second trophic level organism. The secondary consumers, herbivores that will eat plants, and at last will be the tertiary consumers called carnivores, the flesh eaters. They will feed on secondary consumers.

Q. 10. Which trophic level has a maximum number of organisms?

Answer: The bottom most trophic level has the maximum number of organisms because there have to be more food producers than consumers, to sustain life on earth. Suppose if 10 producers (plants) are there and 15 animals than 5 animals will be left hungry and will die and the eaten plants will also be not able to produce food so the remaining 10 animals will die.

Q. 11. How is being a vegetarian advantageous in terms of energy?

Answer: Being a vegetarian will increase the amount of energy taken up by your body. As we know that energy decreases at each successive trophic level. It is least available for the last trophic level. Humans are the final (tertiary) consumers of any food chain; hence if they skip the primary and secondary consumers and directly feed on plants, then they can have the more amount of energy comparative to the energy if they don't skip.

Q. 12. State one reason to justify the position of a man at the apex of most food chains.

Answer: The position of the man is at the apex of most of the food chain because in a food chain the top position is mostly taken by carnivorous animals and in a normal food chain herbivores are the producers, some small organisms are the second consumers and some much larger animals are the third consumers but we come at the last. Humans can consume almost all the animals, also they are the most intelligent organisms so they can change their position by manipulation.

Q. 13. What term is given to the phenomenon where a harmful chemical enters a food chain and starts accumulating?

Answer: The increase in the concentration of harmful chemicals (pesticides) in the body of a living organism at each trophic level of a food chain is called biological magnification. Its level will increase as we move from bottom to top of a food chain. For example, when pesticides are sprayed they enter the food chain through producers while they are absorbing nutrients from the soil. Since herbivores eat many types of plants, therefore their body will accumulate more amounts of pesticides. Similarly, carnivores will feed on more than one herbivore; hence it will have much more amount of pesticide in it.

Q. 14. Name the radiations absorbed by the ozone layer?

Answer: Ozone layer absorbs the harmful Ultraviolet (UV) radiations from sunlight. Then these UV rays split molecular oxygen (O₂) into free oxygen (O), thus keeping the UV radiation from reaching the surface of the Earth.

Q. 15. Does change in lifestyle add waste to the environment?

Answer: No, change in lifestyle does not add waste to the environment. It helps to reduce the amount of waste. The use of eco-friendly products and recyclable materials will lessen the waste produced. Less use of chemical producing products, as people are becoming more aware of the consequences of disturbing the balance of nature.

Q. 16. Name the process by which volume of solid wastes can be reduced.

Answer: The best way to reduce the volume of solid waste is by burning waste at very high temperatures. It is the simplest and earliest form of waste disposal. But this method leads to the release of highly toxic chemicals in the environment which is harmful for the organisms.

Q. 17. Give the difference between paper and glass as a waste product.

Answer:

PAPER	GLASS
It is a biodegradable product.	It is non-biodegradable.
It can be recycled in very less time.	It is hard to recycle.
It does not harm the environment.	It can cause harm to the environment.

Q. 18. List a few practices that lead to the production of non-biodegradable waste.

Answer: When we dispose of them in a garbage pile, the air, moisture, climate, or soil cannot break them down naturally to be dissolved with the surrounding land. They are not biodegradable.

Some practices are:

- Throwing of plastic water bottles and plastic bags.
- Metal scraps improper disposal.
- Construction waste, rubber tires, man-made fibers like nylon etc.

- Useless computer hardware like glass, CDs, DVDs, cellophane, processed woods, cable wires, etc.

Q. 19. What -are the functions of an ecosystem?

Answer: Ecosystem is the interaction of living things with themselves and with the surrounding environment. It's functions in 4 main aspects:

1. Productivity- there should be a balance between the amount of food produced and consumed.
2. Decomposition- The dead and decay matter has to be decomposed successfully to replenish the environment with nutrients.
3. Energy flow- the transfer of energy from one trophic level to another has to follow 10% rule to sustain life.
4. The nutrient cycling-the connection of various components of the ecosystem should be proper to get back the depleted nutrients in the environment.

Q. 20. Why do all food chains start with plants?

Answer: Plants are the only living organism that can consume energy from sunlight to prepare food with the help of a process called photosynthesis. They are the primary producers of every ecosystem. And they are always the largest in number because there have to be more food producers than consumers, to sustain life on earth.

Q. 21. What do you call the organism which feeds on both plants and animals? What is the most likely position of this organism in the food chain?

Answer: The organisms that feed on both plants, as well as animals, are called omnivores. For example pigs, bears, mice, etc. Humans and chimpanzees are also omnivores.

They will come to the third trophic level as they are secondary consumers. This means they will come above herbivores (primary consumers) that can eat only plants. And below carnivores (tertiary consumers) which feed only on flesh.

Q. 22. Explain the difference between the energy captured by producers and energy transferred to consumers.

Answer: A producer is an organism that captures energy and stores it in food as chemical energy. The producers of an ecosystem make energy available to all the other living parts of an ecosystem.

They capture 1% of energy from sunlight and use it to produce food. Then when consumers feed on plants the 10% rule of energy transfer is followed. In that, at each trophic level, about 10% of the energy of previous trophic level is passed to the next trophic level of food chain.

The diagram is shown below:

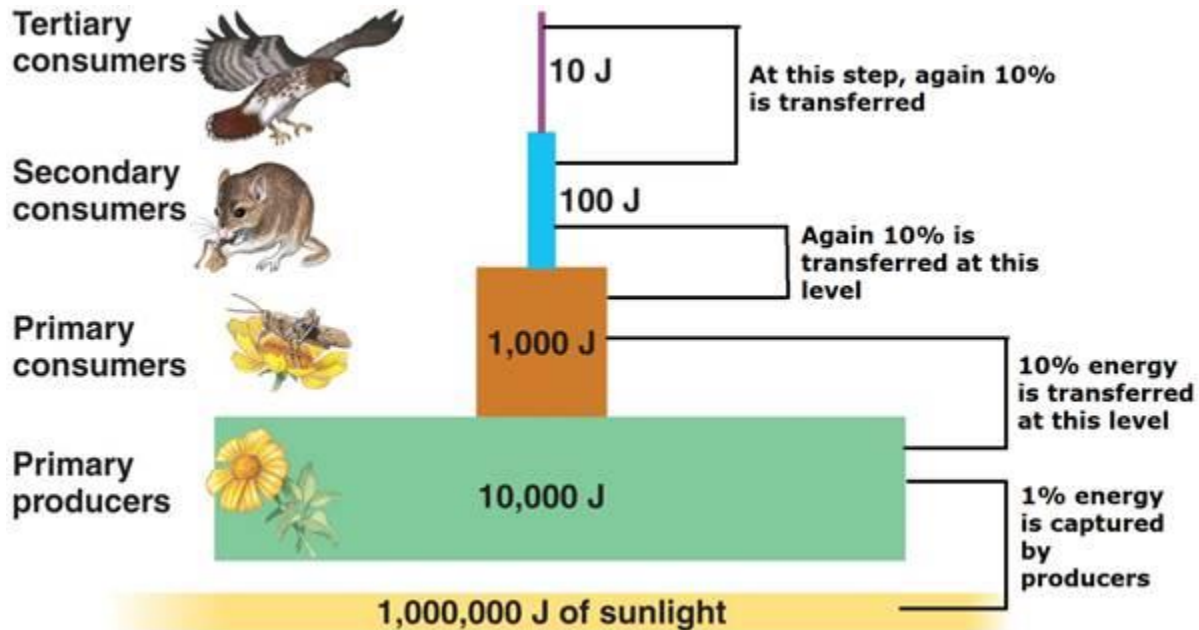

This is how energy transfer varies between sun to plants and then plants to various consumer levels.

Q. 23. Can an organism occupy position in more than one food chain? If so, give an example.

Answer: Yes, an organism can occupy position in more than one food chain. For example: If we consider plants which are the primary producers, their presence is necessary in all the food chains because they are the only organisms which can make their own food by photosynthesis. Because of plants only ecosystem is able to exist. If we compare forest food chain, grassland food chain, pond food chain, we will observe that plants occupy the first trophic level of all the three food chains.

Q. 24. Mention the effects of ozone layer depletion on human beings.

Answer: Ozone layer depletion increases the amount of UV rays that reaches the Earth's surface.

- Skin Cancer- it is estimated that skin cancer rates increased due to the decrease in stratospheric ozone (ozone layer). The most common type of skin cancer is the cause of exposures to UV radiation from sun.

- UV rays have been linked to the development of cataracts, a clouding of the eye's lens.

Q. 25.A. Ultraviolet radiation from sunlight causes a reaction involving O₂ as reactant. What does that produce?

Answer: When UV radiations from the sun reaches earth's atmosphere which is heavily rich in oxygen. Then these UV rays split molecular oxygen (O₂-reactant) into free oxygen (O-Product). Afterwards, this free oxygen reacts with molecular oxygen; it forms ozone (O₃-Finalproduct).

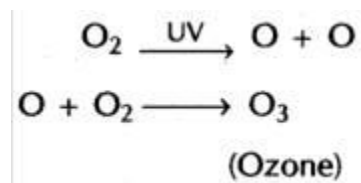

Q. 25.B. What does release of phosphates and nitrates in water bodies lead to?

Answer: Phosphates and nitrates are useful nutrients but when they become too concentrated in our water environments they can cause problems. The main sources of phosphates coming into water bodies are drainage from farmland (fertilizers, runoff from manure, etc.) and sewage effluent (which contains dishwasher detergents, food and drink additives). Nitrates are used in fertilizer, which help farmers to produce more crops which can mean lower food prices.

However, high phosphate and nitrate levels can cause eutrophication – an issue when there is too much nutrient in a water body (e.g. rivers and lakes). This can cause excessive growth of algae and other plants, which then affects water quality, damages plants and animals and stops us using the water. It can cause severe illness in infants and domestic animals.

Q. 26. Give two probable damages that are caused due to ozone layer depletion.

Answer: Effects of the depletion of the ozone layer:

1.1 On human health- Skin Cancer

Today, it is estimated that skin cancer rates increased due to the decrease in stratospheric ozone (ozone layer). The most common type of skin cancer is the cause of exposures to UV radiation from sun.

2. Effects on aquatic ecosystems

The loss of phytoplankton, the basis of the marine food chain, has been observed as the cause of the increase in ultraviolet radiation. For example: Under the ozone hole in

the Antarctic phytoplankton productivity decreased between 6 and 12 percent. That disturbs the ecosystem.

Q. 27. How do CFCs affect ozone layer?

Answer: CFCs are manmade chemicals called chlorofluorocarbons. These substances are found in refrigerators, ACs. Etc. Due to long life and their ability that they do not wash in the rain, so they rise up into the ozone layer above the earth, where they eventually breakdown by heavy exposure to ultraviolet (UV) radiations. When CFC is broken down, it releases chlorine and bromine atoms which can destroy various ozone molecules at once. They cause the ozone layer to breakdown faster than it can replace itself.

Q. 28. Disposal of waste should be done properly. Justify the statement.

Answer: It is because waste has to be disposed in such a manner that it doesn't cause any type of pollution. For example: When wastes are dumped into water bodies they pollute it and also affect the marine life. If it is buried in soil, it will cause depletion of the fertility of the soil and makes the land a waste land. Hence proper disposal of waste is important because:

- a) Garbage can be a source of diseases.
- b) It can be processed to recycle useful components. So, garbage should also be disposed at proper places.
- c) Some garbage contains plastic which can harm our environment. So they should be disposed after taking proper care.

Q. 29. (i) Why is use of disposable paper cups convenient over the use of disposable plastic cups?

(ii) How do biodegradable wastes not cause pollution?

Answer: (i) Disposable paper cups are more convenient over disposable plastic cups because:

- a) Paper cups can decay naturally with the help of decomposers and become harmless after sometime, but plastic cups do not.
- b) They do not pollute the environment as they decay fast but plastic cups do pollute the environment because they are non-biodegradable.
- c) Plastic cups can cause health effect to the living organisms if consumed by chance. But paper cups are made from organic products, like plants.

(ii) Biodegradable wastes are decomposed by the micro-organisms. By the process of decomposition, mineral elements like C, N, O and P are cycled back into the biosphere. This is done in the form of manure, etc.

Q. 30. Draw a pond ecosystem showing its different components.

Answer: A pond ecosystem refers to fresh water ecosystem where there are communities of organism dependent on each other with the prevailing water environment for their nutrients and survival. Usually, ponds are shallow water bodies with a depth of 12-15 feet in which the sun rays can penetrate to the bottom promoting the growth of plants there. It is a natural ecosystem.

The following diagram shows a pond ecosystem.

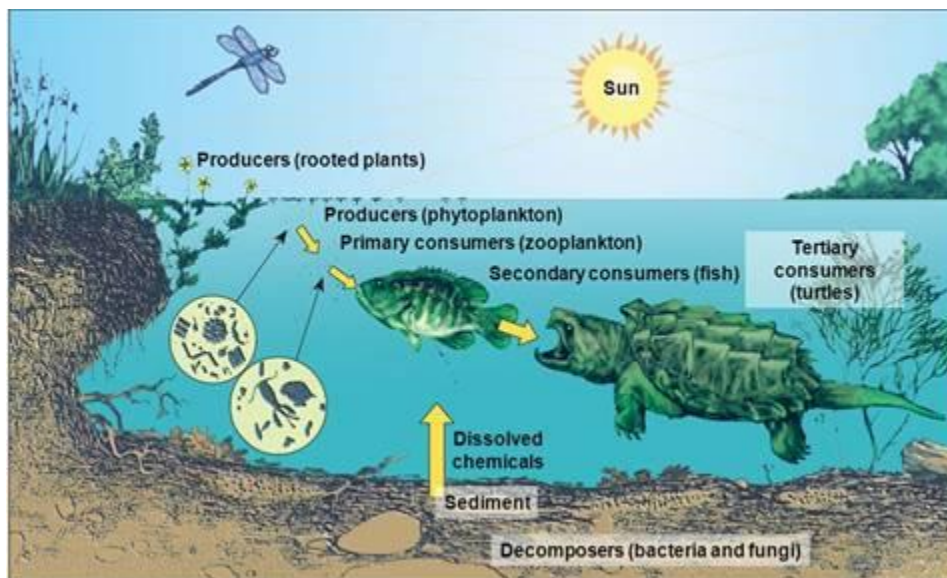

There are two components in the pond ecosystem:

(a) Abiotic – It consists of water, dissolved minerals, oxygen and carbon dioxide. Sunlight is the main source of energy.

(b) Biotic – It includes phytoplanktons, aquatic insects, fishes, and microbes. These organisms are classified as producers, consumers, and decomposers. The energy flows from producer to consumers.

Q. 31. 'Man is only a consumer'. Justify the statement.

Answer: Man is an omnivore, that is, he can feed on both plants and animals. Thus, a man can be a primary consumer when he consumes plant products such as cereals, fruits and vegetables and he can be a secondary consumer when he consumes herbivores such as goat and sheep (in the form of their meat). Thus, a man can be placed at the second as well as the third trophic level of the food chain. Man cannot be

a producer because he cannot convert energy from sunlight, which is chemical energy conversion to food. Only plants have that function to prepare food through photosynthesis. Therefore man can only consume food and is known as a consumer.

Q. 32. How much energy will be available to hawks in the food chain comprising hawk, snake, paddy, and mice if 10,000 J of energy is available to paddy from the Sun?

Answer: Paddy (rice plants) represents the producer level. Paddy plants trap only 1% of the Sun's energy of 10,000J falling on them.

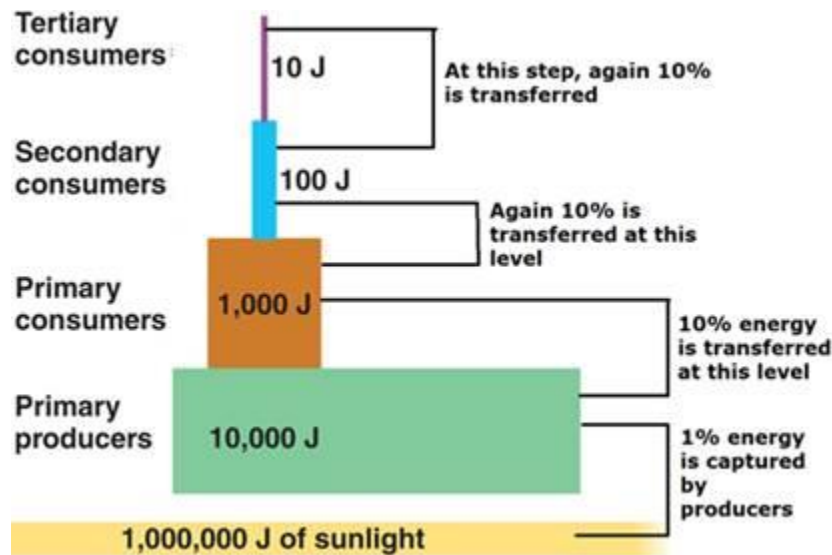

So, the energy available in paddy will be 1% of 10,000 J which will be 100 J. From plants (paddy), the amount of energy passed to the next trophic level is 10%. As we know paddy will be the producers, mice will be the primary consumer, and then the snake will be the secondary consumer and at last will be a hawk, the tertiary consumer. We can now write the food chain and apply ten percent law to it.

(Paddy 100 J) → (Mice 10 J) → (Snake 1 J) → (Hawk 0.1 J)

Thus, the energy available to the hawk in the food chain will be 0.1 J.

Q. 33. The number of trophic levels is limited to 3-4 in a food chain. Give reason.

Answer: The number of trophic levels in an ecosystem is limited and is not more than 3-4. Because the amount of energy flow decreases with successive trophic level, as only 10% of energy is transferred from one trophic level to the next trophic level.

Explanation: At each trophic level in a food chain, a large portion of the energy is utilized for the maintenance of organisms which occur at that trophic level and lost as heat. As a result of this, organisms in each trophic level pass on less and less energy to

the next trophic levels, than they receive. The longer the food chain, the less is the energy available to the final member of the food chain. Food chains generally consist of three or four steps (three or four organisms) because after that the energy available for the next organism will be so small that it will be insufficient to sustain the life of that organism. There are, however, some food chains containing five steps (or five organisms) but there are rarely more than five steps (or five organisms) in a food chain.

Q. 34. Look at the following figures. Choose the correct one and give a reason for your choice.

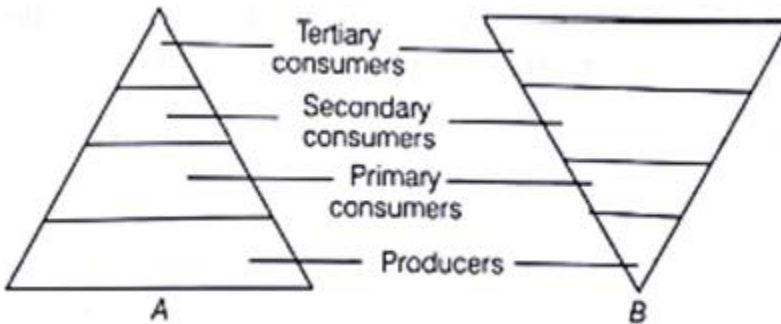

Answer: Correct representation of trophic levels in a food chain is shown in figure A.

The population will decrease as we move from bottom to top of a food chain. The producers will be the highest in number in a food chain because there have to be more food producers than consumers, to sustain life on earth. The top position is mostly taken by carnivorous animals (tertiary consumers), omnivores being the secondary consumers and herbivores being the primary consumers.

A food chain always represents a unidirectional flow of energy from one trophic level to another. Each level in the pyramid represents our level in the food chain. Each level of consumers above the producers has fewer individuals because there is less energy available.

Q. 35. Make an aquatic food chain up to the tertiary consumer level. State the trophic level at which concentration of pesticide is maximum and why?

Answer: An aquatic food chain can go as

Phytoplankton (primary producers) \Rightarrow Zooplankton (primary consumer) \Rightarrow Small fish (secondary consumer) \Rightarrow Large fish (sharks etc, tertiary consumer)

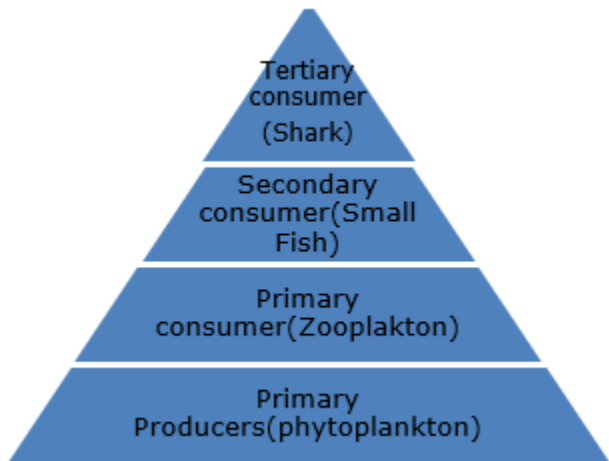

Pesticides are not degradable and progressively accumulated at each trophic level.

Pesticides are used by farmers to protect their crops. These chemicals are absorbed by the plants along with water and minerals from the soil and are taken by aquatic plants and animals as well.

And since these chemicals are non-biodegradable, they will remain in the food chain. Tertiary are the final consumers of this food chain hence, all of this chemical gets in their body when they feed on organisms or plants of the lower trophic level. Its level will increase as we move from bottom to top of a food chain. In this way, these pesticides can cause harm to us. Hence they will be maximum in a tertiary aquatic organism like large fishes.

Q. 36. Why are bacteria and fungi called decomposers? List advantages of decomposers to the environment.

Answer: Bacteria and fungi are called decomposers because they decompose Complex molecules into soluble organic molecules which are absorbed in the soil which will be later used by the plants again to fulfill its nutrient requirement. OR

Because bacteria and fungi break down the dead and decaying organic matter into simpler substances and provide the nutrients back to the soil. When an organism dies, decomposers decay the body extracting the last bit of energy from it. The common left over materials such as water, carbon dioxide, and minerals can then be reused by producers to make sugar through photosynthesis.

The advantages of decomposers are

1. They keep the environment clean by decomposing the dead animals.
2. It prevents the spread of diseases caused by dead bodies of plants and animals like bird flu.

3. They help in making humus.
4. They act as natural scavengers.
5. They help in the recycling of nutrients.

Q. 37. How is Earth kept warm by nature? Describe in detail.

Answer: First, sunlight shines onto the Earth's surface, where it is absorbed and then radiates back into the atmosphere as heat. In the atmosphere, "greenhouse" gases trap some of this heat, and the rest escapes into space. The more greenhouse gases are in the atmosphere, the more heat gets trapped.

Explanation: A greenhouse is a house made of glass. It has glass walls and a glass roof. People grow tomatoes and flowers and other plants in them. A greenhouse stays warm inside, even during winter. Sunlight shines in and warms the plants and air inside. But the heat is trapped by the glass and can't escape. So during the daylight hours, it gets warmer and warmer inside a greenhouse and stays pretty warm at night too.

Similarly, Earth's atmosphere does the same thing as the greenhouse. Gases in the atmosphere such as carbon dioxide do what the roof of a greenhouse does. During the day, the Sun shines through the atmosphere. Earth's surface warms up in the sunlight. At night, Earth's surface cools, releasing the heat back into the air. But some of the heat is trapped by the greenhouse gases in the atmosphere. That's what keeps our Earth warm.

Q. 38. How do human activities affect the environment?

Answer: Human activities affect the environment in the following ways:

- a) Over population-** Due to good medical facilities fewer people are dying and the birth is also continuous. This leads to an increase in population. So they will damage the eco-system more. Without enough trees to filter the air, CO₂ levels increase which carries the potential to damage every single organism on Earth.
- b) Pollution-** Pesticides, herbicides, large landfills, waste from food processing industries, and nuclear waste generated from nuclear reactors and weapons deplete our soil of its nutrients and make it virtually lifeless. The burning of fossil fuels and toxic gases produced in factories causes' air pollution. Effluence from industries, fertilizers run off into nearby water reservoirs, leading to water pollution and damage to the ecosystem.
- c) Global Warming and Ozone Layer Depletion-** Greenhouse gases like CO₂ and methane are believed to lead to global warming. Chlorofluorocarbons (CFCs), used in refrigeration, and aerosols destroy the ozone layer that shields the earth from UV rays.

d) Deforestation- As the population is increasing more food, materials, and shelters are being manufactured at stupendous rates, mostly stemming from forestry. Because of which there is depletion of oxygen as well in the eco-system.

Q. 39.A. Which part of the waste is changed into an agricultural resource?

Answer: Biodegradable waste products are changes in agricultural resources like fertilizers. These biodegradable substances can be broken down by biological processes (like by enzyme or bacterial action). For Examples: cattle dung, cotton, jute, paper, fruit and vegetable peels, leaves etc.

They can be used as various agricultural resources, for example:

- a) Cattle dung is used as natural fertilizers for crops and plants. It is also cost-free.
- b) Jute can be used to prepare bags for storing grains.
- c) Vegetable peels can be used as food for cattle's. Etc.

Q. 39.B. How can pesticides be allowed in beverages?

Answer: Because of lack of regulation, some amount of highly toxic pesticides got in the beverages consumed by people day to day. If ingested over long periods, these chemicals could lead to cancer and failure of the immune system.

Q. 39C. On recycling, waste paper is converted into which product?

Answer: Paper is made from trees, and every single part of the tree is either chopped up to make products or burned to create energy. Although paper waste is biodegradable it's recycling adds more advantage because decomposition takes time(some months or years) but recycling can be done in just some hours.

Paper recycling is a simple process which leads to the recovery of waste paper and converting it into new paper products. Recycling old paper products uses 60% less energy than manufacturing it from new materials, as it would save a lot of trees from being cut down.

Q. 40. Why do harmful chemicals concentrate as we go up in a food chain?

Answer: Harmful chemicals such as pesticides get accumulated in the soil and the water gets polluted and this, in turn, is consumed by the plants to take up nutrients. Those chemicals get accumulated in the plants and go to the next trophic level. This process is also known as biomagnifications. For example, when pesticides are sprayed they enter the food chain through producers while they are absorbing nutrients from the soil. Since herbivores eat many types of plants, therefore their body will accumulate

more amounts of pesticides. Similarly, carnivores will feed on more than one herbivore; hence it will have much more amount of pesticide in it.

Q. 41. State any three environmental problems caused by man.

Answer: The three environmental problems caused by human are:

1) Human activity like the building of industry, like sugar mill, chemical industry, emitted certain harmful effluent that pollutes air and water and soil as well. Improper waste management leads to persistence of non-biodegradable products in the environment which causes health issues to animals and plants.

2) Deforestation- cutting of trees led to the migration of certain animals and cause the extinction of the species. It also results in floods and droughts. The primitive agricultural practice caused soil erosion.

3) The burning of fossil fuels leads to the depletion of ozone layer and may cause several health problems.

Q. 42. Divide the wastes generated from your house into biodegradable and non-biodegradable categories. Suggest methods for their disposal.

Answer: Materials having properties that do not breakdown or decay are called Non-biodegradable.

Examples include:

- Glass
- Metals
- Plastics
- Electronic devices
- Medical waste

Biodegradable materials are composed of waste from living organisms and the actual plant, animal or another organism when its life ends.

Examples of Biodegradable materials often referred to as “bio-waste”, include the following:

- Human and animal waste

- Plant products, wood, unwanted paper, unused food waste, leaves, grass clippings, clothes
- Remains from the death of living creatures

Dustbins aren't the only method to throw waste away. There are various methods to Dispose Waste:

a. Burial Pits/Landfills:

Throwing daily wastes in burial pits or what is also known as landfills is an alternative for dustbins and is the popular waste disposal method. It looks after burying waste in the ground and eliminating foul smell coming from the wastes.

b. Incineration:

Burning of waste at high temperatures and converting them into residue or gaseous products is known as 'Incineration'. It's a better alternative to dustbins since the volume of waste here decreases by 20-30%.

c. Recycling:

The process of reusing the discarded materials and converting them into something new is known as 'Recycling'. It's the third main element in the process of 'Reduce, Reuse and Recycle'. Recycling reduces the harmful effect of greenhouse gases and helps in conservation of resources for future.

d. Composting:

When organic wastes are kept in a pit for a long period of time the microbes start decomposing the waste. If the compost is nutrient rich then it becomes better manure for plants.

Q. 43. What is the environment? What type of substances are the major pollutants of the environment?

Answer: The environment is something you are very familiar with. It consists of the air, water, land, and all the conditions that surround living organisms. It can be living or non-living things. It is the sum total of everything around us.

The pollutants (substances that damage the environment) can be classified into two basic groups:

(a) Non-degradable Pollutants:

These are not broken down by the natural processes like the action of microbes. Most of these Mutants get accumulated in the environment and also get biologically magnified as these move along the food chains in an under the composed state. These may also react with other compounds in the environment to produce toxins.

These can be further subdivided into two more classes:

(i) Waste:

E.g. glass, plastic, phenolic, aluminum cans etc.

(ii) Poisons:

E.g. radioactive substances, pesticides, smog gases, heavy metals like mercury, etc.

(b) Degradable pollutants or Biodegradable Pollutants:

These are natural organic substances which can be decomposed, removed or consumed either by natural processes like biological or microbial action or by some artificial systems, like sewage treatment plants.

The degradable pollutants can be further subdivided into two categories:

(i) Rapidly degradable or non-persistent pollutant:

The degradation of these pollutants is a very faster process. For example, the decomposition of sewage and wastes of animals and plants is a faster process. The domestic sewage can be rapidly decomposed by natural processes. However, the problems become complicated when the input into environment get exceeded of the decomposition or dispersal capacity.

(ii) Slowly degradable or persistent pollutant:

The degradation of these pollutants is a very slower process. It seems as if the amount of pollutant remains unchanged with time. For example, degradation of synthetic compounds and radioactive elements like Iodine 137, takes a longer period of time.

Q. 44. Make two food chains and a food web from the following set of living organisms: Grass, vulture, deer, insect, and snake. Identify the tertiary consumers in both the food chains.

Answer: Food chain is a series of organism feeding on one another. And food web consists of a number of interlinked food chains. There are trophic levels in both which determine the sequence of organisms according to their mode of nutrition.

Plants (producers) get their nutrition from sunlight and prepare their own food. Then comes the primary consumers (herbivores) they cannot prepare their own food hence get their nutrition by feeding on plants. Then comes the secondary (omnivores) and then tertiary consumers (carnivores) they get energy by eating other animals. They all get the nutrition from the organisms of lower trophic levels.

Hence the food chains will be as follows:

(1) Grass->Deer ->Vulture

(2) Grass->Insect->Snake->Vulture

And the food web will be as follows:

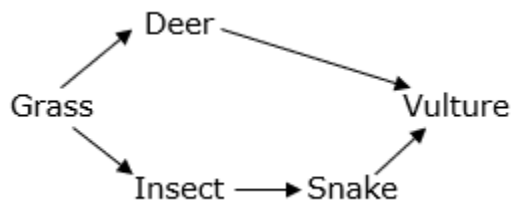

So producer is grass, primary consumers are insect and deer, secondary consumers is a snake and at the apex is vulture the tertiary consumer of both food chain and food web.

Q. 45. What happens once the Sun's energy reaches the Earth? Explain with the help of a diagram.

Answer: Energy from the sun consists of various wavelengths of light. Out of all the rays, only UV (ultraviolet rays) radiations fall on earth. The UV (ultraviolet) radiations from the sun reach the earth's atmosphere which is heavily rich in oxygen. These high energy UV rays split molecular oxygen (O_2) into free oxygen (O). Afterward, this free oxygen reacts with molecular oxygen; it forms ozone (O_3). This ozone layer filters the UV rays and allows only some part of it to fall on earth.

These harmful UV radiations of the sun can cause skin cancer in human and can cause many health hazards like skin cancer, cataract, destruction of plants, etc.

Plants capture sun energy by chlorophyll pigment found on the leaves of the plants.

Then they prepare their food in the form of carbohydrates through the process of photosynthesis. Then when energy flows from one trophic level to another in a food chain and finally gets released into the atmosphere after the decomposition of the organisms carrying it.

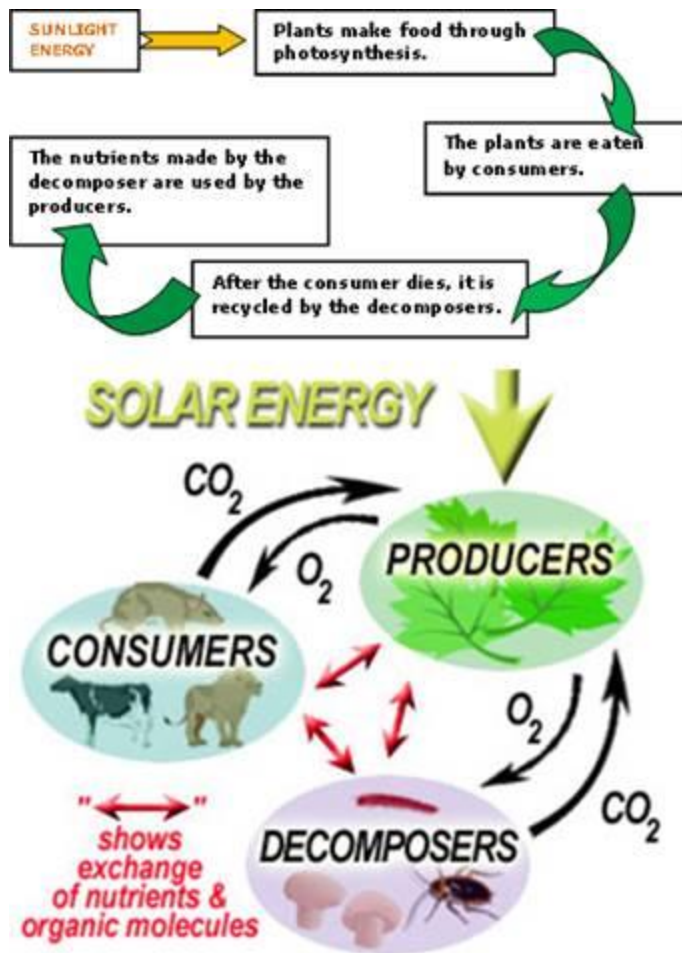

Q. 46.A. If the primary consumer has 400 J of energy. What was the energy trapped by the producer and also write the energy present at the quaternary consumer level?

Answer: According to the 10% law, at each trophic level about 10% of the energy of previous trophic level is passed to the next trophic level of the food chain.

So, if the primary consumers have 400J of energy then producers (first trophic level) will have 10% more of 400J

$$\Rightarrow 400 + 400 \times \frac{10}{100}$$

$$= 400 + 40$$

$$= 440\text{J}$$

So, 440J will be available for the producer.

Now, the energy transferred to the secondary consumer will be= $400 \times 10\%=40\text{J}$

Similarly only 10% of the energy entering the secondary consumers is available for the tertiary consumers. So tertiary consumers will have 4J of energy ($40 \times 10\%$).

Hence the energy available for quaternary consumers= $4 \times 10\%= 0.4\text{J}$

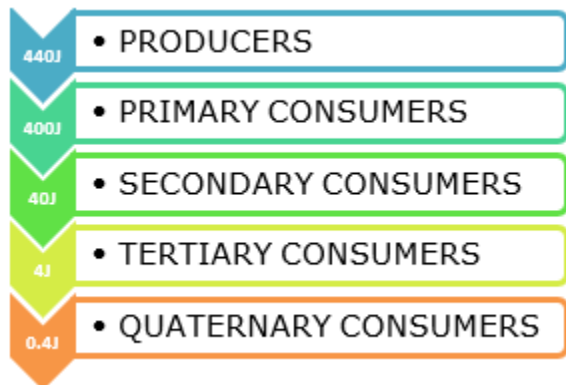

Q. 46.B. State the 10 % law, associated with the flow of energy in trophic levels of organisms.

Answer: 10% rule: The law was given by Lindeman. An average of only 10% of the energy in one trophic level is passed to the next trophic level.

As energy flows in an ecosystem from producers to consumers to decomposers, about 90% of the total energy is lost at each feeding level in the chain because most of the energy is either used by the organism or is given off as heat. The loss of energy at each level can be represented by an energy pyramid. Because of the energy loss, the amount of energy levels in an ecosystem is limited to about 3-5. The transfer of energy is never 100%.

Q. 47. An industry is being established near a town. How can the wastes generated from this industry affect the local environment?

Answer: Industrial waste is the waste produced by industrial activity. It includes any material that is made useless during a manufacturing process. Some examples of industrial wastes are chemical solvents, sludge, metals, ash, paints, paper products, industrial by-products, metals, and various others.

Industries are important for the economic growth and development of a society, but it can also be harmful to the environment. Industrial process can cause pollution to air, water and soil, health issues, extinction of species, and more. Disposing of waste has huge environmental impacts and can cause serious problems like:

Air-Emissions

Industry is a major cause of air pollution, as it results in the emission of pollutants, including organic solvents, respirable particles, sulfur dioxide (SO₂) and nitrogen oxides (NO_x). These pollutants can both harm public health and damage the environment in ways like the greenhouse effect, ozone hole.

Wastewater

The sources of effluent- treated or untreated wastewater that is discharged into surface waters - are many and varied. Untreated wastewater can cause environmental problems including: pollution of groundwater reservoirs, damage of transport and wastewater treatment systems, and degradation of treated wastewater and sludge such that it would disqualify them from being used for agricultural purposes.

Land-Pollution

Leakage from the fuel and energy industries, as well as industries involving hazardous materials, is the main causes of land contamination. Soil contamination is caused by direct exposure to the pollutant, leakage of toxic gases into buildings, and groundwater pollution. The properties of soil result in pollutants remaining in the soil long after the pollution incident. It is taken up by various plants and then it is consumed by humans, causing various health effects.

Hazardous-Materials

Hazardous materials are widely used by almost all the industries. If not properly treated, stored, or dealt with, hazardous materials can cause damage to human health, environment and property.

Radiation

Human and the environment are at-risk from exposure to both ionizing radiation (sources include radioactive materials, x-ray machines, and accelerators) and non-ionizing radiation (from electrical installations, mobile broadcasting centers and lasers).

These harmful radiations can cause many health hazards like skin cancer, cataract, destruction of plants, etc.

Q. 48. Give a detailed account of ozone layer depletion and the harm ozone layer depletion has caused to the ecosystem.

Answer: An ozone molecule (O₃) is composed of three atoms of oxygen. Ozone layer protects life on Earth by absorbing most of the ultraviolet (UV) radiation emitted by the sun. Exposure to too much UV radiation is linked to skin cancer, cataracts, and depression of the immune system, and may reduce the productivity of certain crops.

The ozone layer is reduced when man-made CFC molecules (comprised of chlorine, fluorine, and carbon) reach the stratosphere and are broken apart by short-wave energy from the sun.

These substances that lower the ozone layer do not directly destroy ozone. First they undergo photolysis, forming hydrogen chloride (HCl) or chlorine nitrate (ClONO₂), molecules that do not react with ozone directly, but slowly decompose, giving, among other things, a small number of chlorine atoms (Cl) and Of chlorine monoxide (ClO) molecules that catalyze the destruction of ozone.

The reactions involved in the processes of destruction are more than 100, but can be simplified in the following:

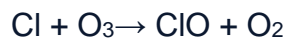

The chlorine atom acts as a catalyst, ie it is not consumed in the reaction, so it destroys thousands of ozone molecules before disappearing.

Effects of Ozone Layers

1. Effects of the depletion of the ozone layer on human health

1.1 Skin Cancer

Today, it is estimated that skin cancer rates increased due to the decrease in stratospheric ozone (ozone layer). The most common type of skin cancer is the cause of exposures to UV radiation from sun.

2. Effects on aquatic ecosystems

The loss of phytoplankton, the basis of the marine food chain, has been observed as the cause of the increase in ultraviolet radiation. For example: Under the ozone hole in the Antarctic phytoplankton productivity decreased between 6 and 12 percent. That disturbs the ecosystem.

3. Effects on terrestrial ecosystems

3.1 Animals

For some species, an increase in UV radiation implies the formation of skin cancer. This has been studied in goats, cows, cats, dogs, sheep and laboratory animals and is

probably pointing out that this is a common feature of several species. Infections in cattle can be aggravated by an increase in UV-B radiation.

3.2 Plants

In many plants UV radiation can have the following adverse effects: alter its shape and damage plant growth; Reduce tree growth; Change flowering times; Make plants more vulnerable to disease and produce toxic substances. There could even be losses of biodiversity and species.

Q. 49. Identify a deadly poisonous gas X found at the higher levels of atmosphere. Write its chemical formula and equation of its formation. Why is damage to X layer a cause of concern?

Answer: Ozone is a simple chemical compound that contains only oxygen atoms, and its effects depend on where in the atmosphere it occurs. In the upper stratosphere, it forms a protective shield against solar ultraviolet radiation, but near the ground, it's a pollutant that can cause respiratory ailments in humans and animals. The creation and destruction of stratospheric ozone depend primarily on natural processes, but near the ground, industrial processes are mostly responsible for its creation.

Hence ozone is the gas found at higher level of atmosphere (stratosphere).

Chemical Composition

An ozone molecule consists of three oxygen atoms (O_3), whereas the stable form of oxygen that normally exists in the atmosphere consists of only two. When certain chemical processes make an extra oxygen atom available, the highly reactive atom binds readily with an oxygen molecule.

Then these UV rays split molecular oxygen (O_2) into free oxygen (O). Afterwards, this free oxygen reacts with molecular oxygen; it forms ozone (O_3).

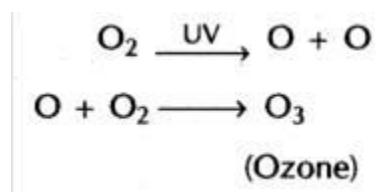

Damage to this layer is of great concern as this ozone protects the earth from harmful UV radiations of sun, by allowing only some percent of rays to fall on the earth's surface. Ozone acts as a filter of sun rays. These rays can cause skin cancer in human and can also affect other living organisms.

Q. 50. Categorize some of the activities performed by you as an eco-friendly person. Suggest some more eco-friendly activities which we should adopt in day-to-day life.

Answer: 1. 3 R's of Waste Hierarchy: The 3 R's of waste hierarchy can reduce the amount of waste generated and improve the waste management processes. Reducing what is produced and what is consumed can reduce the amount of waste that is generated. Reuse items for different purposes instead of disposing them off. Recycle items like aluminum cans, plastic, paper, glass that can be shaped into a new item.

2. Conserve Water and Electricity: It takes energy to produce fresh water and electricity. Few simple ways like turning off lights when not in use, fixing leakages, proper insulation, using maximum daylight, installing energy efficient windows, purchasing energy efficient gadgets can reduce your daily energy consumption.

3. Plant More Trees: We all know why we need more trees on this planet. They give us oxygen, fruits, timber, prevent soil erosion, control floods, and provide shelter to wildlife. Massive scale deforestation in last couple of decades has reduced forest area by significant percentage.

4. Protect Local Water Sources: Hazardous waste materials like paint, oil, ammonia and other strong chemical solutions should never be disposed on the ground as they'll seep into the groundwater. Join local water conservation groups and fight against water polluters who dump their industrial waste in rivers.

5. Drive Less, Walk More: A simple and yet more effective way to live eco-friendly life is to either take public transportation for your daily commuting needs or try pooling in with your office colleagues to save fuel and reduce your carbon footprint. If your office is couple of miles away from home, you can either start half an hour early and walk on foot or ride a bicycle.

6. Buy Energy Efficient Products: Energy efficient products with 5 star energy rating consume less energy and prove to be eco-friendly. For instance, CFL bulbs consume 40% less energy and last 10 times longer than traditional bulbs.

7. Buy locally Grown Products: When you buy or produce locally grown products, you are actually reducing your carbon footprint in the form of using less plastic bags, saving fuel to get vegetables from the market, using less packaged material..... Apart from this, you can also sell surplus to your friends or relatives.

8. Prevent Littering: Litter can originate from construction and demolition sites, households, industries, uncovered trucks, pedestrians, and moving vehicles. Littering can have big impact on environment, wildlife and local tourism industry. Being a responsible citizen, it's our responsibility to make our cities clean and impart same education to our kids.

9. Buy Recycled Products: Always look out for recycling symbol when you visit grocery shop to buy items for your home. That will make you environmentally responsible and eco-friendly. Also, try to carry grocery bag with you to avoid buying items in plastic bags that will later end up in landfills.

10. Join Environmental Groups to Combat Pollution: Protecting mother Earth is everyone's responsibility including you. The best you can do is to join different environmental groups in your city and provide helping hand to make this planet environmentally friendly.

Q. 51.A. Plastic production is increasing day-by-day in spite of the fact that plastic is harmful for the environment. Read the given passage and answer the following questions:

What are the harmful effects of plastic usage?

Answer: ● It Upsets the Food Chain

Because it comes in sizes large and small, polluting plastics even affect the world's tiniest organisms such as plankton. When these organisms become poisoned due to plastic ingestion, this causes problems for the larger animals that depend on them for food. This can cause a lot of problems, each step further along the food chain. Plus, it means that plastic are present in the fish that many people eat every day.

● Land Pollution

When plastic is dumped in landfills, it interacts with water and form hazardous chemicals. When these chemicals seep underground, they degrade the water quality. Wind carries and deposits plastic from one place to another, increasing the land litter. It can also get stuck on poles, traffic lights, trees, fences, tower etc. and animals that may come in the vicinity and might suffocate them to death.

● Air Pollution

Burning of plastic in the open air, leads to environmental pollution due to the release of poisonous chemicals. The polluted air when inhaled by humans and animals affect their health and can cause respiratory problems.

● It is Poisonous

Man artificially makes plastic by using a number of toxic chemicals. Therefore, use of and exposure to plastics has been linked to a number of health concerns affecting people around the world. The processes of making, storing, disposing of, and just being around plastics can be extremely harmful to living things.

● It is Expensive

It costs millions of dollars each year to clean affected areas after exposure, not to mention the loss of life to plants, animals, and people. As land becomes more valuable, just finding a place to put garbage is becoming a problem in many parts of the world.

Q. 51.B. Plastic production is increasing day-by-day in spite of the fact that plastic is harmful for the environment. Read the given passage and answer the following questions

In our day-to-day situation, what is the alternative that we can use instead of plastics?

Answer: We can adopt these methods to lessen the use of plastic:

- Shop Friendly

Plastic bags were once a modern convenience but can be efficiently replaced by reusable bags, many of which fold up compactly in order to be portable. Just think about how many bags you typically carry out of a grocery store, and multiply that by the number of times you grocery shop. That's a lot of plastic! Carry a bag and always reuse plastic bags as much as possible if you have them.

- Get Rid of Bottled Water

People are meant to drink lots of water each day, and plastic water bottles have become a great way to stay hydrated throughout the day. However, most of these are only recommended for single use, and that means that every time someone finishes a bottle it goes into the trash. Many companies now sell reusable water bottles as a substitute, reducing plastic waste and exposure to leaking bottles.

- Recycle Everything

Try and select items that come in non-plastic recycled and recyclable packaging, to do your best to properly handle items that can't be reused. Check everything before you put it in the trash, as more and more items are able to be recycled these days.

Remember that because plastic doesn't break down easily (if ever), recycling plastic means that it is still plastic, just being used for a different purpose. Therefore, you're not actually reducing plastic amounts or exposure, even in the recycling process.

Q. 51.C. Plastic production is increasing day-by-day in spite of the fact that plastic is harmful for the environment. Read the given passage and answer the following questions

What can be learnt as a good citizen in concern for this issue?

Answer: As a good citizen we should take steps for the betterment of the society, state, country we live in. We should learn to:

- Educate Businesses

Speak to local restaurants and businesses about options that they can switch to for packaging, storing, and bagging items. Many companies are starting to come up with excellent low-cost replacements, such as bamboo utensils in place of plastic ones.

- Get Involved

Speak to lawmakers and get involved with government on any level. Encourage development of items, and propose alternatives when applicable.

Q. 52.A. On a visit to his hometown in Gujarat, Aman went to the famous beach in the city. He was shocked to see plastic, paper, waste food, water bottle being thrown away on the beach and also floating on the beach water. On seeing this, Aman asked his father to talk to the care taker of that area to do something regarding this.

What can be the consequence of this situation on the environment?

Answer: Spread of all these non-biodegradable wastes on the beach will go in the oceans with the waves. This will cause ocean pollution or marine pollution. This will lead severe consequences like:

1. Effect of Toxic Wastes on Marine Animals

Oil spill is dangerous to marine life in several ways. The oil spilled in the ocean could get on to the gills and feathers of marine animals, which makes it difficult for them to move or fly properly or feed their children. The long term effect on marine life can include cancer, failure in the reproductive system, behavioral changes, and even death.

2. Disruption to the Cycle of Coral Reefs

Oil spill floats on the surface of water and prevents sunlight from reaching to marine plants and affects in the process of photosynthesis. Skin irritation, eye irritation, lung and liver problems can impact marine life over long period of time.

3. Depletes Oxygen Content in Water

Most of the debris in the ocean does not decompose and remain in the ocean for years. It uses oxygen as it degrades. As a result of this, oxygen levels go down. When oxygen levels go down, the chances of survival of marine animals like whales, turtles, sharks, dolphins, penguins for long time also go down.

4. Effect on Food Chain

Chemicals used in industries and agriculture get washed into the rivers and from there are carried into the oceans. These chemicals do not get dissolved and sink at the bottom of the ocean. Small animals ingest these chemicals and are later eaten by large animals, which then affect the whole food chain.

5. Affects Human Health

Animals from impacted food chain are then eaten by humans which affects their health as toxins from these contaminated animals gets deposited in the tissues of people and can lead to cancer, birth defects or long term health problems.

Q. 52.B. On a visit to his hometown in Gujarat, Aman went to the famous beach in the city. He was shocked to see plastic, paper, waste food, water bottle being thrown away on the beach and also floating on the beach water. On seeing this, Aman asked his father to talk to the care taker of that area to do something regarding this.

What measures you can take as an individual to keep the beach clean?

Answer: LEAVE PLASTIC BEHIND

Stay away from those evil plastic bags! The best you can do is bringing your snacks in reusable bags or containers.

THROW EVERYTHING AWAY

Bring your own bags with you, this will ensure you throw everything away! Trash doesn't just disappear and we all know it, so take everything you brought back with you and that will make the ocean smile.

IF YOU SPOT TRASH

Pick up everything you spot on the beach, but picking up a couple of leftovers will do good to keep the beach clean.

MAKE SMALL CHANGES

Details matter a lot here, for example you could bring a reusable water bottle to your beach day instead of disposable water bottles!.

CAREFUL WITH THAT BONFIRE

Don't you just love roasting some marshmallows on a cozy beach night? We do too! However, try not to burn your debris on the bonfire, it'll go straight to the sand and into the ocean once time goes by. Don't forget to put your fire out properly too.

TAKE CARE OF PETS

If you've brought your puppy to the beach, that's great, nothing beats a puppy trying to swim! However, remember to pick up their poops.

Q. 52.C. On a visit to his hometown in Gujarat, Aman went to the famous beach in the city. He was shocked to see plastic, paper, waste food, water bottle being thrown away on the beach and also floating on the beach water. On seeing this, Aman asked his father to talk to the care taker of that area to do something regarding this.

How can government help in keeping the beach clean?

Answer: There are various departments under government for the cleanliness and hygiene of the environment. Hence Marine department is the main department under government responsible for taking action for marine pollution.

Marine Department

The Marine Department (MD) is responsible for the sea surface cleanliness. The services provided by the department include scavenging floating refuse from sea and foreshore areas, and free of charge domestic refuse collecting service for local vessels inside typhoon shelters and sea-going ships moored in anchorages and government mooring buoys.

Besides regular scavenging services, MD's contractor will also assist green groups to dispose of the refuse collected at beaches after their cleanup operations. The foreshore cleansing force of MD's contractor may also work together with green group volunteers to clean up marine refuse accumulated at foreshore areas which are inaccessible by land.

The Department has deployed wardens to patrol marine beaches and marine reserve on a daily basis by both land and sea, giving advice to visitors and taking law enforcement action when necessary.

Education/publicity programs are being conducted to promote public awareness in clean shorelines through:

- conveying message of keeping a clean and healthy environment through a wide range of education programs including seminars, school talks, field studies and exhibition;
- producing posters, leaflets and other publications to enhance public understanding on the importance of keeping the cleanliness in beaches;
- Erecting different sign and information boards along the coast of oceans to remind the beach visitors of keeping the shoreline clean.

Q. 52.D. On a visit to his hometown in Gujarat, Aman went to the famous beach in the city. He was shocked to see plastic, paper, waste food, water bottle being thrown away on the beach and also floating on the beach water. On seeing this, Aman asked his father to talk to the care taker of that area to do something regarding this.

What values are shown by Aman?

Answer: Aman is concerned for the environment. He got himself involved in taking steps for the betterment of the ecosystem. He asked his father to talk to the caretaker and encourage development of items, and propose alternatives which can be applied.

Q. 53.A. While explaining the recent developing ozone hole on Antarctica, teacher makes a remark that 'without ozone layer, organisms cannot survive on Earth'. Kalpana gets curious about the various aspects of ozone layer and asks some questions to her teacher.

How is ozone layer formed?

Answer: When UV radiations from the sun reaches earth's atmosphere which is heavily rich in oxygen. Then these UV rays split molecular oxygen (O₂) into free oxygen (O). Afterwards, this free oxygen reacts with molecular oxygen; it forms ozone (O₃).

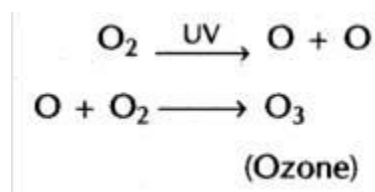

This ozone now protects the earth from harmful UV radiations of sun, by allowing only some percent of rays to fall on the earth's surface. Ozone acts as a filter of sun rays. These rays can cause skin cancer in human and can also affect other living organisms.

Q. 53.B. While explaining the recent developing ozone hole on Antarctica, teacher makes a remark that 'without ozone layer, organisms cannot survive on Earth'.

Kalpna gets curious about the various aspects of ozone layer and asks some questions to her teacher.

What has led to its depletion?

Answer: The ozone layer is reduced when man-made CFC molecules (comprised of chlorine, fluorine, and carbon) reach the stratosphere and are broken apart by UV energy from the sun.

These substances that lower the ozone layer do not directly destroy ozone. First they undergo photolysis, forming hydrogen chloride (HCl) or chlorine nitrate (ClONO₂), molecules that do not react with ozone directly, but slowly decompose, giving, among other things, a small number of chlorine atoms (Cl) and Of chlorine monoxide (ClO) molecules that catalyze the destruction of ozone.

The reactions involved in the processes of destruction are more than 100, but can be simplified in the following:

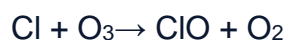

The chlorine atom acts as a catalyst, ie it is not consumed in the reaction, so it destroys thousands of ozone molecules before disappearing.

Q. 53.C. While explaining the recent developing ozone hole on Antarctica, teacher makes a remark that 'without ozone layer, organisms cannot survive on Earth'. Kalpna gets curious about the various aspects of ozone layer and asks some questions to her teacher.

What measures can an individual take to protect ozone layer?

Answer: Measures that can be taken are:

1. Limit private vehicle driving

This is because vehicular emissions eventually result in the release of smog. This in turn also damages the ozone layer causing it to deteriorate. You can choose to take the public transport or use a bicycle. Another great way to restrict the use of car is by opting for Car Pooling. If you do want to use a vehicle, then it is recommended to switch to an electric or hybrid vehicle.

2. Use eco-friendly household cleaning products

Usage of Eco-friendly and natural cleaning products for household chores is a great way to prevent ozone depletion. This is because many of these cleaning agents contain toxic chemicals that interfere with the ozone layer. A lot of supermarkets and health stores sell cleaning products that are toxic-free and made out of natural ingredients.

3. Avoid using pesticides and prevent ozone depletion

Pesticides may be an easy solution for getting rid of weed, but are harmful for the ozone layer. The best solution for this would be to try using natural remedies, rather than heading out for pesticides.

4. Buy air-conditioning and refrigeration equipment that do not use HCFCs as refrigerant.

Challengers

Q. 1. The diagram shows part of a river into which sewage is being pumped. Some of the effects of adding sewage to the river are shown in the graph. At which point in the river are decomposers most active?

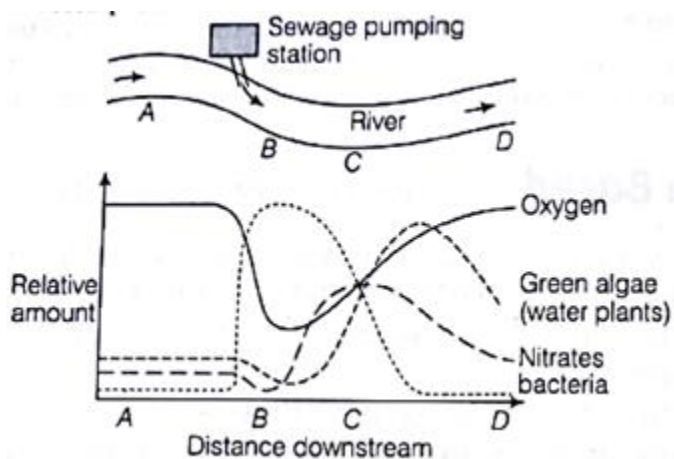

- A. D
- B. C
- C. B
- D. A

Answer: At B the concentration of blue green algae is high, they take up the atmospheric oxygen and then the nitrated bacteria convert it into ammonia, so that it can be used by aquatic environment. In this way they release nutrients back into the environment for other organisms to use.

Also because of high concentration of Oxygen at B point, helps them to use oxygen to gain energy and drive their own life processes. They will again make the water fresh and clear.

Q. 2. The diagram shows the flow of energy through an ecosystem.

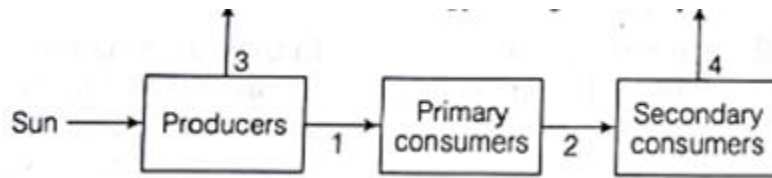

The smallest amount of energy transferred between organisms and the largest amount of energy lost to the ecosystem is represented by which arrows?

	Smallest energy transfer	Largest energy loss
(a)	4	3
(b)	2	1
(c)	2	3
(d)	1	4

- A. (a)
- B. (b)
- C. (c)
- D. (d)

Answer: The smallest amount of energy transferred between organisms is shown by arrow number 4. Because as we go above in a food chain the amount of energy transferred is reduced by 10%. And the largest amount of energy loss to the ecosystem is in the form of heat. It is shown by arrow number 3. This is because producers (plants) take energy from sunlight and only 1% of it is used to prepare food rest other is lost in the form of heat.

Q. 3. The following graph shows the concentration of oxygen in a river, measured at stations 1.5, each 100 m apart. A sewage outflow is observed just after station 1. At which stations will the concentration of organic matter be lowest?

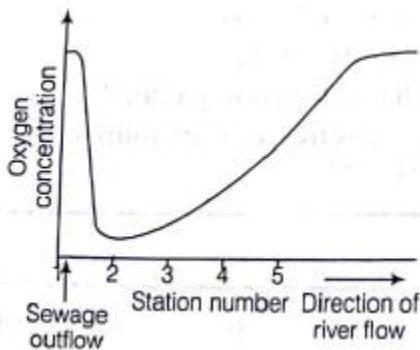

- A. 1 and 5
- B. 2 and 3

- C. 3 and 4
- D. 4 and 5

Answer: At 1 and 5 the concentration of organic matter will be lowest because there were no decomposers. Whereas in 2,3 and 4 the decomposers were using the high amount of oxygen to decompose the organic material from sewage.

Q. 4. Fertilizers are used on farmlands to increase the nutritive quality of soil and thus, the crop productivity. However, they greatly impact our environment in negative ways. A fertilizer Industry is planning to release nitrate free or reduced nitrate containing fertilizer to make it more environment friendly. This control of nitrate rich fertilizers is necessary because

- A. Nitrates cause acid rain, killing trees and fishes when released in the environment.
- B. They decrease the natural fertility of the soil.
- C. Nitrates may lead to excessive growth of water plants.
- D. It poisons different crop plants.

Answer: As nitrogen is an essential element for plant growth and development; however, due to environmental pollution, high nitrate concentrations accumulate in the edible parts of these leafy vegetables, particularly if excessive nitrogen fertilizer has been applied. Consuming these crops can harm human health.

Q. 5. The diagram shows the organisms in a habitat.

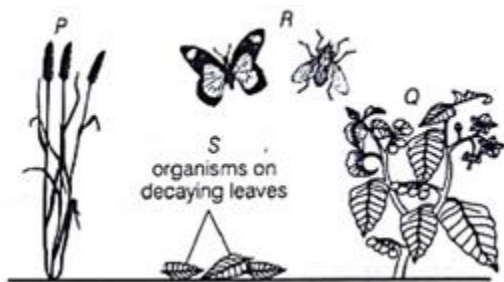

Which of the following indicates the feeding relationships of these organisms?

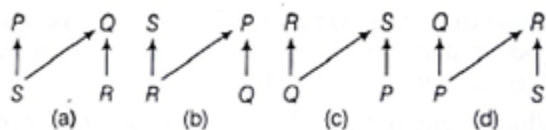

- A. (a)
- B. (b)
- C. (c)
- D. (d)

Answer: R are the primary consumers which feed on plant Q. Decomposers are the organisms which feed on dead and decaying matter S. Then these decaying matters help in the growth of plants by providing nutrients to feed then from soil.

Q. 6. The diagram represents the flow of substances within a balanced ecosystem. The boxes are various trophic levels. Which box represents the producers?

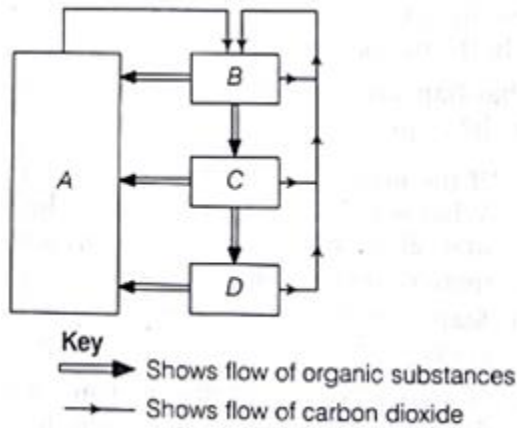

- A. B
- B. D
- C. A
- D. C

Answer: A box represents the primary trophic level which is producer in an ecosystem. Because of two reasons:

- 1) They are highest in number.
- 2) They provide energy for the beginning of a food chain.