

10

Cell Cycle and Cell Division

Multiple Choice Questions (MCQs)

Q. 1 Meiosis in diploid organisms results in

- (a) production of gametes
- (b) reduction in the number of chromosomes
- (c) introduction of variation
- (d) All of the above

💡 Thinking Process

Sexual reproduction involves the union of male and female gametes. Fusion of gametes is accomplished by the plasmogamy (union of protoplasm) followed by karyogamy (union of nucleus). This results in doubling of chromosome numbers in the resultant cell.

Ans. (d) Meiosis is a reduction division which reduces the chromosomes number to half in gametes. Since, it is a special kind of cell division in which exchange of genetic material takes place that brings about variation in next generations. So all options are characteristic features of meiotic cell division.

Q. 2 At which stage of meiosis does the genetic constitution of gametes is finally decided

- (a) Metaphase-I
- (b) Anaphase-II
- (c) Metaphase-II
- (d) Anaphase-I

Ans. (d) The genetic constitute of gametes is finally decided at the anaphase-I after which each cell receives half the chromosome number, *i.e.*, from ' $2n$ ' in parent cell it changes to ' n ' in daughter cells. During this phase, the two homologous of each chromosome pair separate and move toward opposite poles drawn by microtubule of the spindle apparatus.

These are separated further by anaphase-II, wherein sister chromatids of each chromosome separate and move toward opposite poles. It cannot be metaphase-I or metaphase-II because during these stages. The chromosomes or chromatids, merely arrange themselves at the metaphasic plate.

Q. 3 Meiosis occurs in organisms during

- (a) sexual reproduction (b) vegetative reproduction
(c) Both (a) and (b) (d) None of these

Ans. (a) Meiosis occurs in sexually reproducing organisms to reduce the chromosome number to half before their gametes unit, so, as to maintain the constant chromosome number ($2n$) in the progeny.

Vegetative reproduction is a kind of asexual reproduction occurring in plants and does not involve the formation and fusion of gametes.

Q. 4 During Anaphase-I of meiosis

- (a) homologous chromosomes separate
(b) non-homologous autosomes separate
(c) sister chromatids separate
(d) non-sister chromatids separate

Ans. (a) During **Anaphase-I** homologous chromosomes separate, while sister chromatids remain associated at their centromeres.

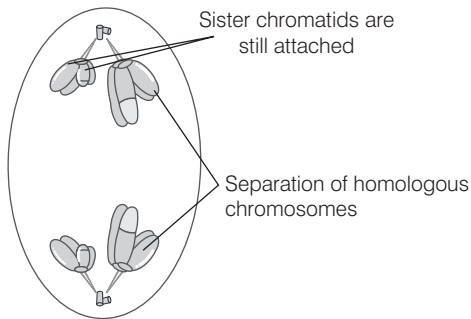

Rest of the options do not take place during anaphase-I of meiosis

Q. 5 Mitosis is characterised by

- (a) reduction division
(b) equal division
(c) Both (a) and (b)
(d) pairing of homologous chromosomes

Thinking Process

Growth and multiplication is the characteristic feature of all living organisms. It is accomplished by mitotic cell division by which there is an increase in the number of cells. This is also involved in asexual reproduction in lower organisms and plants.

Ans. (b) Mitosis is characterised by equal division because the chromosome numbers in the daughter cells remain same as that of parent cell. While reduction division is the characteristic of meiosis.

Q. 6 A bivalent meiosis-I consists of

- (a) two chromatids and one centromere
- (b) two chromatids and two centromeres
- (c) four chromatids and two centromeres
- (d) four chromatids and four centromeres

Ans. (c) The complex formed by a pair of synapsed homologous chromosome is called bivalent or a tetrad. It has two centromeres and four chromatids. Rest of the options are incorrect.

Q. 7 Cells which are not dividing are likely to be at

- (a) G_1
- (b) G_2
- (c) G_0
- (d) S-phase

Thinking Process

Cell division is a very important process in all living organisms. The cell prepares itself, and DNA duplication and cell growth takes place prior to cell division.

Ans. (c) G_0 , G signifies growth, and zero means no growth takes place at this stage. It is also called quiescent stage (G_0). Some cells of the body like heart cells, neuron which do not divide, exit at G_1 stage and enter G_0 of the cell cycle which is an inactive stage. The cells in this stage remain metabolically active but no longer proliferate unless called on to do so depending on the requirement of the organism.

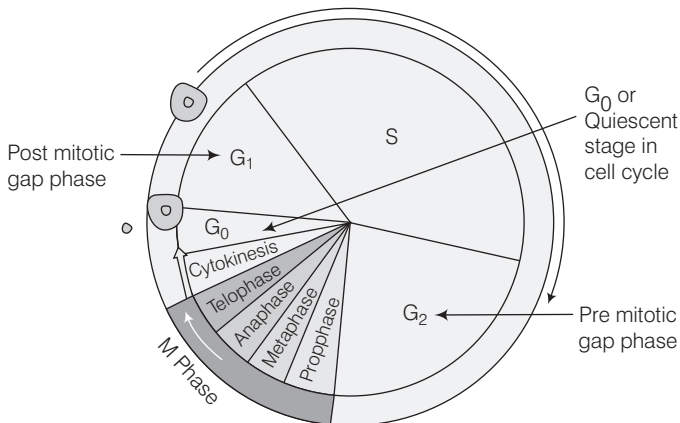

A diagrammatic view of cell cycle

G₁ phase is the first growth phase or post mitotic gap phase that lasts between the end of mitotic cycle and initiation of DNA replication.

G₂ phase is the second growth phase or premitotic gap phase in which cell prepares itself to enter cell division, i.e., mitosis.

S-phase is the synthetic phase in which chromosomes replicate, i.e., DNA replication, formation of new chromatin fibres, etc.

Q. 8 Which of the events listed below is not observed during mitosis?

- (a) Chromatin condensation
- (b) Movement of centrioles to opposite poles
- (c) Appearance of chromosomes with two chromosomes joined together at the centromere
- (d) Crossing over

Ans. (d) Crossing Over is the phenomenon of genetic exchange between homologous pair of chromosomes and is a characteristic feature of meiotic cell division. It does not occur in mitosis. Rest of the options represent stages in mitosis.

Q. 9 Identify the wrong statement about meiosis

- (a) Pairing of homologous chromosomes
- (b) Four haploid cells are formed
- (c) At the end of meiosis the number of chromosomes are reduced to half
- (d) Two cycle of DNA replication occurs

Ans. (d) Two cycles of DNA replication does not occur in meiosis. Other options (a), (b) and (c) define the meiotic cell division.

Q. 10 Select the correct statement about G_1 phase

- (a) cell is metabolically inactive
- (b) DNA in the cell does not replicate
- (c) it is not a phase of synthesis of macromolecules
- (d) cell stops growing

Ans. (b) G_1 phase means gap 1 phase. It is the interval between mitosis and initiation of DNA replication. The cell is metabolically active and continuously grows but does not replicate the DNA content. The cell also synthesizes proteins that are required for DNA replication.

Rest of the options are not characteristics of G_1 phase.

Very Short Answer Type Questions

Q. 1 Between a prokaryote and a eukaryote, which cell has a shorter cell division time?

💡 Thinking Process

Prokaryotic cell has simple cell structure and cellular organisation. It's nucleus does not contain nuclear membrane.

Ans. Prokaryotic cell has shorter cell cycle than the eukaryotic cell.

Q. 2 Which of the phases of cell cycle is of longest duration?

Ans. Interphase is of the longest duration. *It has following events and is divided in the following phases*

- (a) **G_1 phase** (Gap 1) Corresponds to the interval between mitosis and initiation of DNA replication. Cell is metabolically active and continuously grows but does not replicate its DNA.
- (b) **S-phase** (Synthesis phase) Marks the period during which DNA synthesis or replication takes place.
 - (i) Amount of DNA per cell doubles.
 - (ii) No increase in chromosome number.
- (c) **G_2 Phase** (Gap 2) Proteins are synthesised for the preparation of cell division, while cell growth continues.

Q. 3 Name a stain commonly used to colour chromosomes.

Thinking Process

The chromosomes are the thickest and the shortest at metaphase. They are stained for karyotyping for further study of chromosomes.

Ans. Acetocarmine and Giemsa stain can be used to stain the chromosomes.

Q. 4 Which tissue of animals and plants exhibits meiosis?

Ans. Meiosis is a special kind of cell division, also called as reduction division, which occurs in germ cells or sex cells of male and female reproductive organs of plants and animals. They produce male (σ^{r}) and female (f) gametes that take part in sexual reproduction.

Q. 5 Given that the average duplication time of *E. coli* is 20 minutes, how much time will two *E. coli* cells take to become 32 cells?

Ans. 1 hour -20 minutes

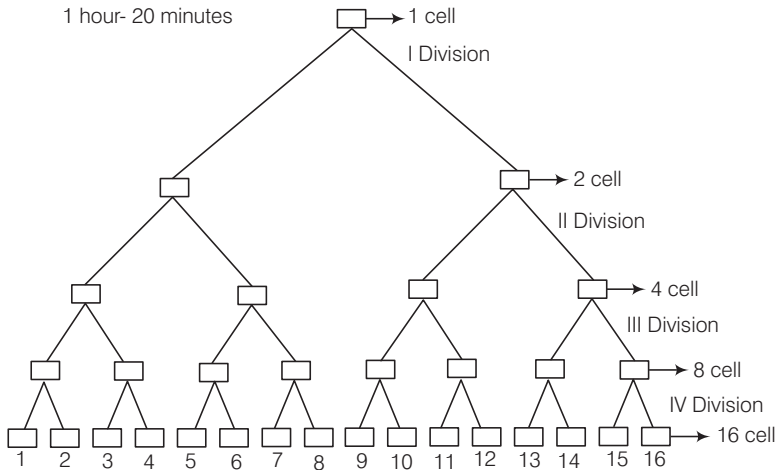

These are the 4 subsequent cell divisions to produce 16 cells and each division takes =20 min
 Total time = $20 \times 4 = 80$ minutes or 1 hr 20 minutes

So, 1 cell produces 16 cells in 1 hour 20 minutes and
 2 cells produces 32 cells in 1 hour 20 minutes.

Q. 6 Which part of the human body should one use to demonstrate stages in mitosis?

Ans. All the cells in the human body are somatic cells except germinal cells in the male and female reproductive organs. The somatic cells divide by mitotic cell division for growth and regeneration. These can be used to demonstrate mitosis.

Q. 7 What attributes does a chromatid require to be classified as a chromosome?

Ans. Chromatid is one copy of a duplicated chromosome, which is joined to the other copy centromere. The duplication of chromosome material takes place at synthetic phase of cell cycle.

During mitosis, late **metaphase** and early anaphase, there is longitudinal splitting of chromosomes and thus two chromosome get separated, to get divided into the daughter cells.

Q. 8 The diagram shows a bivalent at prophase-I of meiosis. Which of the four chromatids can cross over?

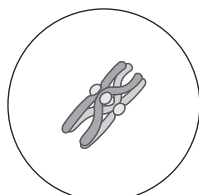

Prophase-I

Ans. The homologous chromosomes lie parallel to each other in leptotene stage. Each chromosome has four chromatids and are bivalent. The non-sister chromatids of homologous chromosomes cross over in pachytene stage of prophase- I.

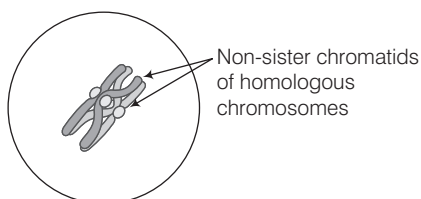

Pachytene of prophase-I of meiosis

Q. 9 If a tissue has at a given time 1024 cells, how many cycles of mitosis had the original parental single cell undergone?

Ans. The parental cell undergoes 10 divisions of mitotic cycle to give 1024 cells.

Q. 10 An anther has 1200 pollen grains. How many pollen mother cells must have been there to produce them?

💡 Thinking Process

The pollen mother cell ($2n$) undergoes meiotic cell divisions, each such cell produces four daughter cells with haploid (n) number of chromosomes.

Ans. Three hundred pollen mother cells have to be there to produce 1200 pollen grains. because one pollen mother cell will produce four pollen grains.

Q. 11 At what stage of cell cycle does DNA synthesis take place?

Ans. Synthetic phase or S-phase of interphase, is the stage of cell cycle where DNA synthesis or replication takes place.

Q. 12 It is said that the one cycle of cell division in human cells (eukaryotic cells) takes 24 hours. Which phase of the cycle, do you think occupies the maximum part of cell cycle?

💡 Thinking Process

Cell cycle is a sequential event and is under genetic control. Every cell prepares itself before it starts dividing. This preparation takes place in interphase stage of the cell cycle.

Ans. If a cell takes 24 hours to divide, it will have 18- 20 hours time to spend on interphase stage to prepare itself to undergo cell division.

Q. 13 It is observed that heart cells do not exhibit cell division. Such cells do not divide further and exit ... phase to enter an inactive stage called... of cell cycle. Fill in the blanks.

Ans. It is observed that heart cells do not exhibit cell division. Such cells do not divide further and exit **G₁** phase to enter an inactive stage called **quiescent stage (G₀)** of cell cycle.

Muscle cells when reach a level of maturity, no longer divide and just perform their function all through its life. Similar is the case with **nerve cells** too which are highly specific and lack the ability to divide once they get specialised. They remain in that state until they die.

Q. 14 In which phase of meiosis are the following formed? Choose the answers from hint points given below.

- (a) Synaptonemal complex
- (b) Recombination nodules
- (c) Appearance/activation of enzyme recombinase
- (d) Termination of chiasmata
- (e) Interkinesis
- (f) Formation of dyad of cells

Hints (a) Zygotene, (b) Pachytene,
 (c) Pachytene, (d) Diakinesis,
 (e) After Telophase-I/before prophase of meiosis-II,
 (f) Telophase-I/after meiosis-I.

Ans. (a) Synaptonemal complex **zygotene**.
 (b) Recombination nodules **pachytene**.
 (c) Appearance/activation of enzyme recombinase **telophase-I/after, meiosis-I ...**.
 (d) Termination of chiasmata **diakinesis**.
 (e) Interkinesis **after telophase-I/before prophase of meiosis-II**.
 (f) Formation of dyad of cells **pachytene**.

Short Answer Type Questions

Q. 1 State the role of centrioles other than spindle formation.

💡 Thinking Process

The animal cell has few membrane less cell organelles. Centrosome is one of them. Two cylindrical structures are the part of centrosome, these are called centrioles.

Ans. The two centrioles in the centrosome lie perpendicular to each other. Each has organisation like a cart wheel. These form the basal body of cilia and flagella of plant/animal cells besides forming spindle fibre in animal cell division. It also helps in the formation of microtubules and sperm tail.

Q. 2 Mitochondria and plastids have their own DNA (genetic material). What is known about their fate during nuclear division like mitosis?

Ans. The DNA present in mitochondria and chloroplast is extrachromosomal DNA. It has nothing to do with the nuclear divisions. In mitosis, only nuclear DNA takes part.

Q. 3 Label the diagram and also determine the stage at which this structure is visible.

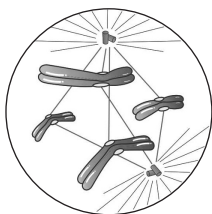

Thinking Process

Cell division is an important event in the cell cycle. The cell passes through various phases in which number of changes are seen in its nuclear content.

Ans. The diagram shows the transition stage between prophase and metaphase stage of mitotic cell division.

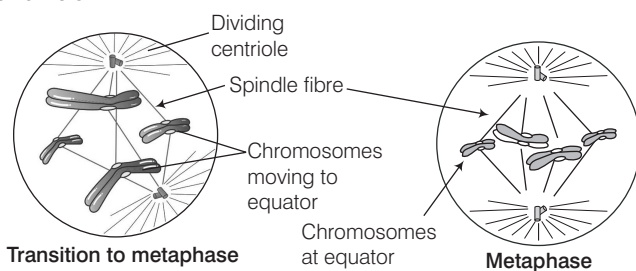

Q. 4 A cell has 32 chromosomes. It undergoes mitotic division. What will be the chromosome number (n) during metaphase? What would be the DNA content (C) during anaphase?

Thinking Process

Mitotic cell division helps in the growth of organism and its development. It also plays a vital role in asexually reproducing organisms.

Ans. The mitotic cell division occurs in somatic cells of an organism. The chromosome number in the daughter cells remain same as that of the parent (dividing) cell, so even at metaphase or anaphase, the chromosome number does not change.

The DNA content gets doubled at the synthetic phase of interphase and gets divided at anaphase but the chromosome number remains same.

Q. 5 While examining the mitotic stage in a tissue, one finds some cells with 16 chromosomes and some with 32 chromosomes. What possible reasons could you assign to this difference in chromosome number. Do you think cells with 16 chromosomes could have arisen from cells with 32 chromosomes or *vice-versa*?

Ans. Such a condition may arise in case of a mosaic or mosaicism, which denotes preserve of two or more populations of cells with different genotypes in one individual.

It can result from various mechanisms including non-disjunction, anaphase lagging and endoreplication. It may also result from a mutation during development which is propagated to only a subset of the adult cells.

In this case, cells with 16 chromosomes could have arisen from cells with 32 chromosomes.

Q. 6 The following events occur during the various phases of the cell cycle. Name the phase against each of the events.

- (a) Disintegration of nuclear membrane
- (b) Appearance of nucleolus
- (c) Division of centromere
- (d) Replication of DNA

Ans. (a) Prophase (b) Telophase
(c) Anaphase (d) S-phase

Q. 7 Mitosis results in producing two cells which are similar to each other. What would be the consequence if each of the following irregularities occur during mitosis?

- (a) Nuclear membrane fails to disintegrate
- (b) Duplication of DNA does not occur
- (c) Centromeres do not divide
- (d) Cytokinesis does not occur

💡 Thinking Process

Cell division is under genetic control and is highly precised phenomenon. However, some mistake occur sometimes at genetic and molecular level in cell cycle which may lead to certain abnormalities.

Ans. (a) If nuclear membrane fails to disintegrate, the spindle fibres would not be able to reach chromosomes and they would not move towards opposite poles of the cell. In certain protozoans, such as *Amoeba*, the spindle is formed within the nucleus and this is called intranuclear mitosis or pre-mitosis.

(b) If DNA duplication does not occur than cell might not be able to surposs S-phase of cell-cycle as no chromosome formation will take place, and will not be able to enter M-(mitotic phase) or if in case it enters mitosis the cycle will cease,

(c) If the centromeres do not divide,one of the daughter cell will receive a complete pair of chromosomes and other cell would not get any of them. This may result in trisomy.

(d) If cytokinesis does not occur, then multinucleate condition called coenocyte, syncytium is produced, as in *Rhizopus* and *Vaucheria*, etc.

Q. 8 Both unicellular and multicellular organisms undergo mitosis. What are the differences, if any, observed in the process between the two?

Ans. In unicellular organisms, the type of cell division is known as amitosis in which somatic cell is divided into two parts directly. In multicellular organisms occurs which is an indirect process.

Both cell division in unicellular and multicellular organisms undergo mitosis have differences as below

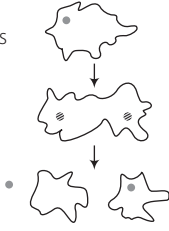
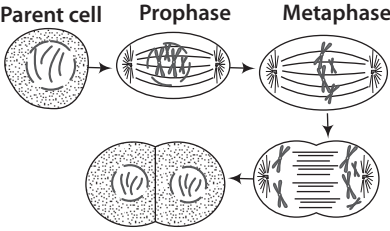
Cell Division in Unicellular Organism (Amitosis)	Cell Division in Multicellular Organism (Mitosis)
<p>It is direct division of cellular and nuclear content. Without the formation of chromosomes.</p> <p>Different phases of cell divisions are not seen.</p> <p>Stage 1 Specialised proteins speed up change</p> <p>Stage 2 Nucleus divides.</p> <p>Stage 3 Cytoplasm divides having each of the two nuclei</p> <p>Division of acellular organism by amitosis</p> 	<p>Nucleus and cellular content do not divide directly and involves formation of chromosomes.</p> <p>It involves different phases of cell division.</p> <p>Parent cell Prophase Metaphase</p>  <p>Two daughter cells Anaphase</p> <p>Division of cell in multicellular organism by mitosis</p>

Q. 9 Name the pathological condition when uncontrolled cell division occurs.

Ans. Cancer is the pathological condition in which the cells loose control over cell division and this results into malformation of the organ in which such cell division occurs.

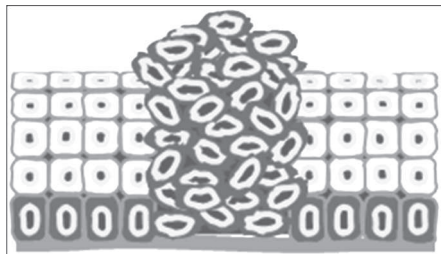

Underlying tissue

Q. 10 Two key events take place, during S-phase in animal cells, DNA replication and duplication of centriole. In which parts of the cell there events occur?

Ans. DNA replication takes place in nucleus and duplication of centriole occurs in the cytoplasm. Centriole forms spindle fibres during cell division in animal cells which direct the movement of chromosomes within the cell. The position of centriole determines the position of the nucleus and plays a crucial role in the spatial arrangement of the cell.

Q. 11 Comment on the statement-meiosis enables the conservation of specific chromosome number of each species even through the process per se results in reduction of chromosome number.

Ans. Meiosis is the mechanism by which conservation of specific chromosome number of each species is achieved across generations in sexually reproducing organisms. Even though the process results in reduction of chromosome number by half, it is gradually conserved by union of male gamete (n) and female gamete (n) in next generation.

Meiosis also increases the genetic variability in the population of organisms from one generation to the next.

Q. 12 Name a cell that is found arrested in diplotene stage for months and years. Comment in 2-3 lines how it completes cell cycle?

Ans. Meiotic arrest at diplotene stage commonly occurs in mammalian oocytes. In females, meiosis starts in the embryo and proceeds as far as diplotene, when the chromosomes become diffused and the cells are referred to as being in the dictyate stage. This arrest is under hormonal control.

In many amphibian oocytes and insects with a long period of immaturity, the oocyte may be arrested in the dictyate stage for many years and spend a prolonged period in diplotene.

This stage is characterised by formation of lampbrush chromosomes where intense RNA synthesis occurs and most of the genes in the DNA loops are actively transcribed and expressed.

Q. 13 How does cytokinesis in plant cells differ from that in animal cells?

Ans. Difference between cytokinesis in plant cell and animal cell is as follows

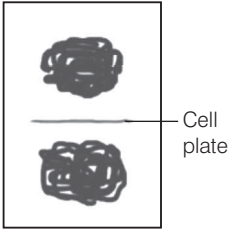
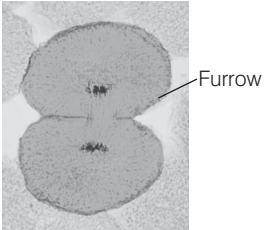
Cytokinesis in Plant Cell	Cytokinesis in Animal Cell
The division of cytoplasm takes place by cell plate formation.	The division of cytoplasm takes place by cleavage.
The cell plate formation starts at the centre of the cell and grow outward, toward the lateral walls.	Cleavage starts at the periphery and then moves inward, dividing the cell into two parts.
 <p data-bbox="379 1514 486 1541">Plants cell</p>	 <p data-bbox="797 1514 923 1541">Animals cell</p>

Long Answer Type Questions

Q. 1 Comment on the statement- Telophase is reverse of prophase.

Ans. The following contrasting differences reveals that telophase is reverse of prophase, in cell division

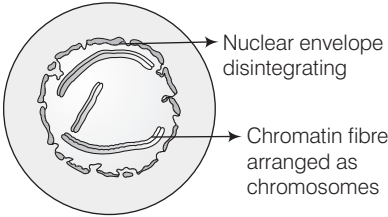
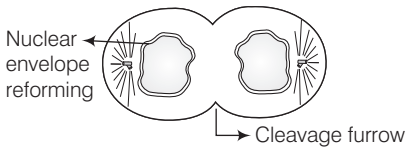
Prophase	Telophase
<p>1st stage of (karyokinesis) in cell division, Viscosity of cytoplasm increases. The indistinct and interind DNA condense to form elongated chromosomes. The chromatin disappears and chromosome fibres get shortened and thickened. Spindle fibres appears (awards the poles from the centriole connected in animals with astral rays and in plants without asters Nucleolus degenerate completely.</p> <p>Cell organelles such as ER, Golgi complex disorganise, and difference between cytoplasm and nucleoplasm disappears.</p>	<p>Last stage of karyokinesis in cell division. Viscosity of cytoplasm decreases. Chromosome groups reorganise themselves into nuclei. Chromosomes elongate and overlap each other to form chromatin. Spindle fibres disappear around the poles. Astral rays also disappear in plants. Nuclear envelope appears and two daughter nuclei are formed at the poles. Cell organelles, i.e., ER and Golgi complex are reformed in the cell. Nucleoplasm also appears in the chromatin area. Making it distinct from rest of cytoplasmic area.</p>
 <p style="text-align: center;">Late prophase</p>	 <p style="text-align: center;">Telophase</p>

Q. 2 What are the various stages of meiotic prophase-I? Enumerate the chromosomal events during each stage?

Ans. Prophase-I occurs over a long duration and involves several complicated changes in meiotic cell division. It is important because genetic recombination and variation in sexually reproducing organism occurs due to the events of this phase.

Leptotene

- (i) The chromatin network opens out and threads become clear.
- (ii) The chromosomes are thin, slender and long.
- (iii) Chromosome number is diploid.

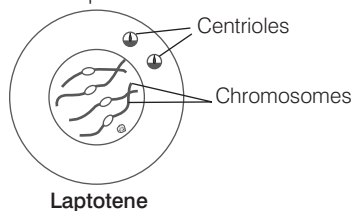

Zygotene

- (i) Corresponding chromosomes become intimately associated.
- (ii) The process of pairing is known as synapse. It is so exact that pairing is not merely between corresponding chromosomes but between corresponding individual units.
- (iii) The chromosomes become shorter and thicker.

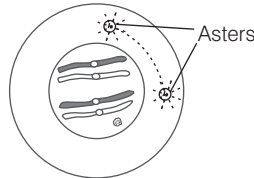

Zygotene

Pachytene or Pachynema

- (i) The synaptic chromosomes become very intimately associated.
- (ii) The pair of chromosomes becomes short and thick.
- (iii) Crossing over occurs at this stage. Chiasmata are clearly seen.

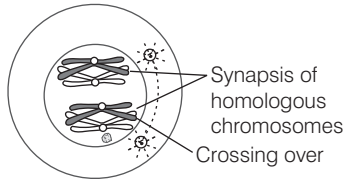

Pachytene

Diplotene

- (i) Homologous chromosomes start separating from one another.
- (ii) Chiasmata tend to slip out of the chromosomes. This is known as terminalisation of chiasmata.
- (iii) Chromosomes start separating out but the separation is not complete.
- (iv) Nuclear membrane and nucleolus start disappearing.

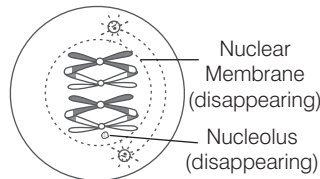

Diplotene

Diakinesis

- (i) The bivalents condense further and get randomly distributed.
- (ii) The separation of paired chromosomes is almost complete.
- (iii) Terminalisation of chiasmata is almost complete.
- (iv) Nuclear membrane and nucleolus disappear.

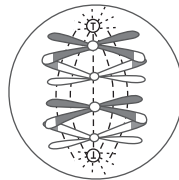

Diakinesis

Q. 3 Differentiate between the events of mitosis and meiosis.

Ans. Mitotic cell division results into the increase in the number of cells that have same genetic composition whereas meiosis has its importance in the life cycle of sexually reproducing organisms.

Mitosis	Meiosis
<p>Event</p> <p>Prophase</p> <ul style="list-style-type: none"> ◆ Chromomeres are not conspicuous. ◆ Prophase is of shorter duration. ◆ Prophase is simpler and is hardly distinguishable into substages. ◆ Each chromosome has two distinct chromatids. ◆ No bouquet stage is recorded. ◆ Chiasmata are absent. <p>Metaphase</p> <ul style="list-style-type: none"> ◆ Centromeres produce a single metaphasic plate. ◆ Chromosomes are independent and do not show connections. ◆ Only the centromeres lie at the equator. The limbs of chromosomes are oriented in various direction. ◆ A centromere is connected with both the spindle poles. ◆ Two chromatids of a chromosome are genetically similar. <p>Anaphase</p> <ul style="list-style-type: none"> ◆ A centromere splits length-wise to form two centromeres in the beginning of anaphase. ◆ Anaphasic chromosomes are single stranded. 	<ul style="list-style-type: none"> ◆ Chromomeres are quite conspicuous. ◆ Prophase-I is of longer duration while prophase-II is very brief. ◆ Prophase-I is complicated and is divisible into five substages. Prophase-II is, however, very simple. ◆ Chromosomes of prophase-I do not show distinct chromatids. ◆ Chromosomes of animals and some plants show convergence towards one side during early prophase-I. It is known as bouquet stage. ◆ Chiasmata or visible connections between homologous chromosomes of bivalents are observed during diplotene, diakinesis (prophase- I) and metaphase- I. ◆ A double metaphasic plate is formed by centromeres in metaphase-I but only one in metaphase-II. ◆ Homologous chromosomes are interconnected. Hence, the chromosomes occur in pairs or bivalents in metaphase-I. They are however, free in metaphase-II. ◆ Limbs of the chromosomes mostly lie at the equator while the centromeres project towards the poles in metaphase-I. ◆ A centromere is connected to one spindle pole in metaphase-I, but both in metaphase-II. ◆ The two chromatids of a chromosome are often genetically different due to crossing over. ◆ Centromeres do not divide during anaphase-I but do so in anaphase-II. ◆ Chromosomes are double-stranded in anaphase-I, but single stranded in anaphase-II.

Mitosis	Meiosis
<ul style="list-style-type: none"> Similar chromosomes move towards the opposite poles in anaphase. <p>Telophase Telophase is longer and produces interphase nuclei.</p> <p>Cytokinesis Cytokinesis follows every mitosis. It produces two new cells.</p>	<ul style="list-style-type: none"> Dissimilar chromosomes move toward the opposite poles both in anaphase-I and anaphase-II. Telophase-I is shorter and nuclei now enter the interphase. Cytokinesis often does not occur after first or reductional division. It is then simultaneous after second division resulting in four new cells.

Q. 4 Write brief note on the following

- (a) Synaptonemal complex
- (b) Metaphase plate

Ans. (a) Synaptonemal complexes are zipper-structures which are assembled between homologous chromosomes during the prophase of the first meiosis. Their assembly and disassembly correlate with the successive chromatin rearrangements of meiotic prophase namely the condensation, pairing, recombination and dysfunction of homologous chromosomes.

They are considered to be the structures that control the number and distribution of reciprocal exchanges between homologous chromosomes. They also are known to convert cross over into functional chiasmata .

- (b) In metaphase, the centromeres of the chromosomes assemble themselves on the metaphase plate (equatorial plate), an imaginary line that is equidistant from two centrosome poles. This even alignment is due to the opposing kinetochore microtubules. At this plate, chromosomes, especially sister chromatids are attached to the bundle of four to eight spindle fibres.

Q. 5 Write briefly the significance of mitosis and meiosis in multicellular organism.

Ans. Multicellular organisms grow and develop with the involvement of mitotic cell division. Meiosis occurs in them to form gametes in their reproductive phase of life cycle.

Significance of Mitosis

- (i) Multicellular plants and animals start life as single cells. The process of mitosis gives rise to many cells which differentiate to form tissues, organs and organ-systems of the organism.
- (ii) It results in increase in size and growth of an organ.
- (iii) Cell reproduction is used to form new cells to renew certain tissues and to replace worn out cells.
- (iv) Mitosis is also involved in asexual reproduction in some organisms like in unicellular. *Amoeba* and multicellular *Hydra* as well as in vegetative reproduction in plants.

Significance of Meiosis

- (i) Meiosis is the mechanism by which conservation of specific chromosome number of each species is achieved across generations in sexually reproducing organisms.
- (ii) Meiosis also increases the genetic variability in the population of organisms from one generation to the next. Variations are very important for the process of evolution.

Q. 6 An organism has two pair of chromosomes (*i.e.*, chromosome number= 4). Diagrammatically represent the chromosomal arrangement during different phases of meiosis-II.

💡 Thinking Process

Meiosis is a reduction in which division, chromosome number reduces to half in daughter cells. The number reduces as half set of chromosomes move to 2 daughter cells of the meiosis-I. Thus two cells with half set of chromosomes again re-enter meiosis-II which is a similas to mitotic cell division.

Ans.

